

ZOV

KITCHEN SOLUTIONS

| KÜCHENLÖSUNGEN

ZOV

KITCHEN SOLUTIONS

KÜCHENLÖSUNGEN

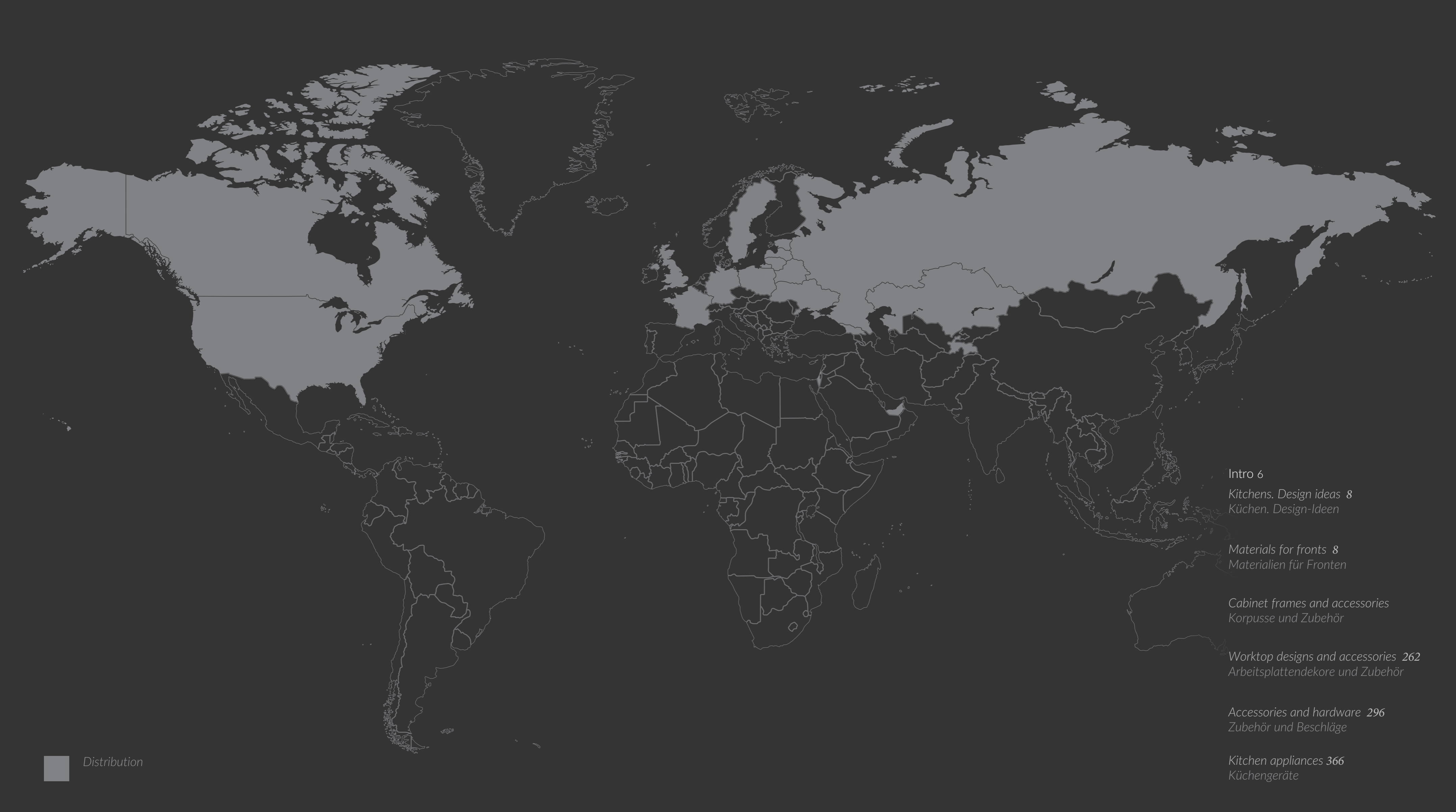

Distribution

Intro 6

Kitchens. Design ideas 8
Küchen. Design-Ideen

Materials for fronts 8
Materialien für Fronten

Cabinet frames and accessories
Korpuse und Zubehör

Worktop designs and accessories 262
Arbeitsplattendekore und Zubehör

Accessories and hardware 296
Zubehör und Beschläge

Kitchen appliances 366
Küchengeräte

INTRO

EN

ZOV GROUP is a family company established in 1997 and managed by its members in the third generation. For many consecutive years our products are being highly commended for outstanding quality and innovative design. Over the past 20 years we have acquired a high level of proficiency in producing trendy and functional kitchen furniture. ZOV GROUP possesses around 50 000 square meters of production floor space. Over 2 000 highly qualified employees are involved in production process. High-technology equipment, fully automated lines and a wide range of materials, finishes and fittings enable us to translate your dream kitchen into reality. We constantly upgrade our production facilities and implement new technologies for being able to offer variously designed products that will be affordable for every customer. A very important part of our business is professional trainings and regular participation in trade fairs and exhibitions for furniture and industrial equipment, which keep us up to date on current trends in the industry. Today our developed dealer network counts over 900 retail stores in Belarus and abroad (Russia, Ukraine, Kazakhstan, Lithuania, Latvia, Estonia, Poland, Germany, England, Georgia, Tajikistan, Israel, UAE and other). All our products meet ISO 9001:2008 Quality Management System Requirements.

DE

Die Unternehmensgruppe ZOV ist ein im Jahre 1997 gegründetes Familienunternehmen, das bereits in der dritten Generation von Familienmitgliedern geführt wird. Schon viele Jahre hintereinander werden unsere Produkte für hervorragende Qualität und innovatives Design gelobt. In den letzten 20 Jahren haben wir ein sehr hohes professionelles Niveau in der Herstellung von trendigen und funktionellen Küchenmöbeln erreicht. Die Unternehmensgruppe ZOV verfügt über ca. 50 000 Quadratmeter Produktionsflächen. Über 2 000 hochqualifizierte Fachleute sind am Herstellungsverfahren beteiligt. Hochtechnologiemaschinen, vollautomatisierte Linien und eine sehr reiche Auswahl an Materialien, Beschichtungen, Beschlägen und dem Zubehör ermöglichen uns Ihre Traumküche zu verwirklichen. Wir modernisieren ständig unsere Fertigungsanlagen und führen neue Technologien ein, so dass unsere Produkte verschiedenartig und vor allem erschwinglich sein können. Ein unentbehrlicher Teil unserer Tätigkeit ist die Aus- und Fortbildung, sowie auch die regelmäßige Teilnahme an Fachmessen und Ausstellungen für Möbel und Industriemaschinen, damit wir rund ums Jahr up to date zu den aktuellen Trends in der Möbel- und Holzbearbeitungsindustrie sind. Unser umfassendes Partnernetz zählt über 900 Einzelhandelsgeschäfte nicht nur in Weißrussland, sondern auch im Ausland (in Russland, in der Ukraine, in Kasachstan, Litauen, Lettland, Estland, Polen, Deutschland, England, Georgien, Tadschikistan, Israel, in den Vereinigten Arabischen Emiraten u.a.). Alle unsere Produkte entsprechen den Anforderungen der ISO 9001:2008 Qualitätsnorm.



KITCHENS.
DESIGN IDEAS

KÜCHEN.
DESIGN-IDEEN

VERANO

EN

FRONTS T308 Natural alder wood **FRONTS COLOR** 133 (patina Graphite) / 135 (without patina) **DECORATIVE FRONTS** Front with lattice insert #1 **GLASS FRONTS** With/without cross bars, mullion glass front #1 **HANDLES/KNOBS** 47-01 (128mm hole spacing), 47-01 **WORKTOP** 38mm, HPL, color Galicia **WORKTOP EDGE** ABS Galicia **TABLE TOP** 38mm, KS with square edged profile, solid ash wood, color #180 wax stain Dark **PLINTH** Straight, chipboard/alder wood veneer, color 133 (patina Graphite) / 135 (without patina), height 97mm **DECORATIVE ELEMENTS** Pilaster #9, corbel shelf LGP-1(600) / LGP-2(600) with hooks; corner filler NMU

DE

FRONTEN T308 Echtholz Erle **FRONTFARBE** 133 (Patina Graphit) / 135 (ohne Patina) **DEKORFRONTEN** Front mit Gitterfüllung #1 **GLASFRONTEN** Mit/ohne Sprossen, Glasfront #1 mit Sprossen **GRIFFE / KNÖPFE** 47-01 (128mm Bohrabstand), 47-01 **ARBEITSPLATTE** 38mm, HPL, Farbe Galicia **KANTEN** ABS Galicia **TISCHPLATTE** 38mm, KS mit geradem Kantenprofil, Massivholz Esche, Farbe #180 Wachsbeize Dunkel **SOCKEL** Gerade, Spanplatte/Erlenholz-Furnier, Farbe 133 (Patina Graphit) / 135 (ohne Patina), Höhe 97mm **DEKORELEMENTE** Pilaster #9, Konsolenregal LGP-1(600) / LGP-2(600) mit Haken; Winkelpassstück NMU





VERANO



EN_Pilsater #9
DE_Pilaster #9

GLION

EN

FRONTS T501 Natural ash wood **FRONTS COLOR** NCS S 6005-G50Y **HANDLES** RC089-02 **WORKTOP** 38mm, HPL, color Latteri **WORKTOP EDGE** ABS Latteri **DINING TABLE** 37mm, Timber Sabia **OPEN SHELVING** 18mm, Timber Sabia / 19mm, lacquered MDF, color NCS S 6005-G50Y Matt **PLINTH** Straight, chipboard/ash wood veneer, color NCS S 6005-G50Y, height 97mm

DE

FRONTEN T501 Echtholz Esche **FRONTFARBE** NCS S 6005-G50Y **GRIFFE** RC089-02 **ARBEITSPLATTE** 38mm, HPL, Farbe Latteri **KANTEN** ABS Latteri **ESSTISCH** 37mm, Timber Sabia **OFFENE REGALE** 18mm, Timber Sabia / 19mm, MDF lackiert, Farbe NCS S 6005-G50Y Matt **SOCKEL** Gerade, Spanplatte/Eschenholz-Furnier, Farbe NCS S 6005-G50Y, Höhe 97mm





GLION



ADRIA

EN

FRONTS T506 Natural ash wood **FRONTS COLOR** NCS S 1510-R90B (patina Graphite) **GLASS FRONTS** Without cross bars **HANDLES/ KNOBS** 15134.25 (128mm hole spacing), 24134.25 **WORKTOP** 38mm, HPL, color Oak Rigato **WORKTOP EDGE** ABS Oak Rigato **PLINTH** Straight, chipboard/ash wood veneer, color NCS S 1510-R90B, height 97mm **DECORATIVE ELEMENTS** Pilaster #2, straight balustrade (straight balusters), crown moulding B-3K straight (strip in smooth design) **DINING TABLE** Palermo, solid ash wood, color #182 oil-wax finish Rosewood, W/L/H: 740/1190/770mm **KITCHEN APPLIANCES** Gas hob AEG HG567455VB, built-in oven AEG BER455120B

DE

FRONTEN T506 Echtholz Esche **FRONTFARBE** NCS S 1510-R90B (Patina Graphit) **GLASFRONTEN** Ohne Sprossen **GRIFFE/KNÖPFE** 15134.25 (128mm Bohrabstand), 24134.25 **ARBEITSPLATTE** 38mm, HPL, Farbe Eiche Rigato **KANTEN** ABS Eiche Rigato **SOCKEL** Gerade, Spanplatte/Eschenholz-Furnier, Farbe NCS S 1510-R90B, Höhe 97mm **DEKORELEMENTE** Pilaster #2, gerade Balustrade (gerade Baluster), Kranzprofil B-3K gerade (Leiste im glatten Design) **ESSTISCH** Palermo, Massivholz Esche, Farbe #182 Öl-Wachs-Finish Palisander, B/L/H: 740/1190/770mm **KÜCHENGERÄTE** Gaskochmulde AEG HG567455VB, Einbaubackofen AEG BER455120B





ADRIA



FORTWOOD

EN

FRONTS T509 Natural ash wood **FRONTS COLOR** 120 **GLASS FRONTS** Without cross bars, clear glass / «Loft-1» matt glass (polymer pattern Chrome) **HANDLES/KNOBS** 47-01 (128mm hole spacing), 47-01 **WORKTOP** 38mm, KS with square edged profile, solid ash wood, color #182 oil-wax finish Rosewood **WALL EDGING STRIP** Solid ash wood, color #182 oil-wax finish Rosewood **SUSPENDED SHELVES** 19mm, chipboard/ash wood veneer, color 120 **PLINTH** Straight, chipboard/ash wood veneer, color 120, height 147mm **DECORATIVE ELEMENTS** Base wine rack cabinet WR60(870)_45R, base end shelf cabinet ES45(870)_60R, base cabinet BC45(870)GS_60 with glass shelf, decorative panel MBN-1(870)_60

DE

FRONTEN T509 Echtholz Esche **FRONTFARBE** 120 **GLASFRONTEN** Ohne Sprossen, Klarglas / «Loft-1» Mattglas (Polymermuster Chrom) **GRIFFE/KNÖPFE** 47-01 (128mm Bohrabstand), 47-01 **ARBEITSPLATTE** 38mm, KS mit geradem Kantenprofil, Massivholz Esche, Farbe #182 Öl-Wachs-Finish Palisander **WANDABSCHLUSSLEISTE** Massivholz Esche, Farbe #182 Öl-Wachs-Finish Palisander **HÄNGEREGALE** 19mm, Spanplatte/Eschenholz-Furnier, Farbe 120 **SOCKEL** Gerade, Spanplatte/Eschenholz-Furnier, Farbe 120, Höhe 147mm **DEKORELEMENTE** Weinregal WR60(870)_45R, Abschlussregal ES45(870)_60R, Unterschrank BC45(870)GS_60 mit Glaseinlegeboden, Dekorblende MBN-1(870)_60





FORTWOOD



BELLAGIO

EN

FRONTS T511 Natural ash wood **FRONTS COLOR** 111 / 137 (without patina) **GLASS FRONTS** Without cross bars **HANDLES** N/A **WORKTOP** 38mm, HPL, color Valmasino Marble Light Grey **WORKTOP EDGE** ABS Valmasino Marble Light Grey **PLINTH** Straight, chipboard/ash wood veneer, color 111 / 137 (without patina), height 97mm **DECORATIVE ELEMENTS** Pilaster #3, #9; lower decorative support OND-1(100/50); decorative support OD-9(820); crown moulding LGB-1 straight; decorative trim NM-1

DE

FRONTEN T511 Echtholz Esche **FRONTFARBE** 111 / 137 (ohne Patina) **GLASFRONTEN** Ohne Sprossen **GRIFFE** N/A **ARBEITSPLATTE** 38mm, HPL, Farbe Marmor Valmasino Hellgrau **KANTEN** ABS Marmor Valmasino Hellgrau **SOCKEL** Gerade, Spanplatte/Eschenholz-Furnier, Farbe 111 / 137 (ohne Patina), Höhe 97mm **DEKORELEMENTE** Pilaster #3, #9; untere dekorative Stütze OND-1(100/50); dekorative Stütze OD-9(820); Kranzprofil LGB-1 gerade; Zierblende NM-1





BELLAGIO



EN_Pilsater #3
DE_Pilaster #3

SOLEGIO

EN

FRONTS T512 Natural ash wood **FRONTS COLOR** 110 (gold patina) **DECORATIVE FRONTS** Front with lattice insert #2, front Combi-V (veneered MDF / glass), front Combi-G (veneered MDF / lattice insert #2), set of fronts «Trio», convex curved solid fronts (R=1000mm) **GLASS FRONTS** With cross bar **HANDLES/KNOBS** 71-T3 (128mm hole spacing), 77-T3 **WORKTOP** 38mm, KS with double chamfer edge profile (chamfer 3x3mm/2), solid ash wood, color #184 oil-wax finish Chestnut / 38mm, HPL, color Ferro Bronze **WORKTOP EDGE** Solid ash wood, edge profile N°1 **PLINTH** Plinth with shaped recess, solid ash wood, color 110 (gold patina), height 97mm; shaped convex curved plinth, MDF/ash wood veneer, color 110 (gold patina), height 97mm **DECORATIVE ELEMENTS** Pilaster #2; lower decorative support OND-1(100/50); decorative support OD-6-1(820), OD-6-2; crown moulding B-3K straight (strip in smooth design); decorative shelf P1 (barrel-shaped balusters), width 600mm; corner filler NMU

DE

FRONTEN T512 Echtholz Esche **FRONTFARBE** 110 (goldene Patina) **DEKORFRONTEN** Front mit Gitterfüllung #2, Front Kombi-W (furnierte MDF-Platte / Glas), Front Kombi-G (furnierte MDF-Platte / Gitterfüllung #2), Fronten-Set «Trio», konvexe Vollfronten (R=1000mm) **GLASFRONTEN** Mit Sprosse **GRIFFE/KNÖPFE** 71-T3 (128mm Bohrabstand), 77-T3 **ARBEITSPLATTE** 38mm, KS mit zweifach gefastem Kantenprofil (Abschrägung 3x3mm/2), Massivholz Esche, Farbe #184 Öl-Wachs-Finish Kastanie / 38mm, HPL, Farbe Ferro Bronze **KANTEN** Massivholz Esche, Kantenprofil N°1 **SOCKEL** Sockel mit Ausfräsung, Massivholz Esche, Farbe 110 (goldene Patina), Höhe 97mm; geformter konvex gebogener Sockel, MDF/Eschenholz-Furnier, Farbe 110 (goldene Patina), Höhe 97mm **DEKORELEMENTE** Pilaster #2; untere dekorative Stütze OND-1(100/50); dekorative Stütze OD-6-1(820), OD-6-2; Kranzprofil B-3K gerade (Leiste mit glattem Design); dekoratives Regal P1 (tonnenförmige Baluster), Breite 600mm; Winkelpassstück NMU





SOLEGIO



EN_Decorative support OD-6-1(820)
 DE_Dekorative Stütze OD-6-1(820)

MADEIRA

EN

FRONTS T514 Natural ash wood **FRONTS COLOR** 102 **DECORATIVE FRONTS** Front with lattice insert #2 **GLASS FRONTS** Without cross bars **HANDLES** 503-D1 (128mm hole spacing) **WORKTOP** 38mm, HPL, color Galicia **WORKTOP EDGE** Solid ash wood, edge profile №1 **WORKTOP UPSTAND** 7mm, HPL, color Galicia (height 20mm) **PLINTH** Decorative plinth #1, MDF/ ash wood veneer/solid ash wood, color 102, height 147mm **DECORATIVE ELEMENTS** Pilaster #5; lower decorative support OND-1(150/75), OND-1(150/150); upper decorative support OVD-1(150); decorative support OD-4; crown moulding B-3K Combi straight (strip in smooth design); decorative trim NM «Plate rack» (width 596mm); valance #4; straight balustrade (shaped balusters); pelmet PM-3 straight; decorative range hood P-15; decorative panel BPD-6-1; corner filler NMU

DE

FRONTEN T514 Echtholz Esche **FRONTFARBE** 102 **DEKORFRONTEN** Front mit Gitterfüllung #2 **GLASFRONTEN** Ohne Sprossen **GRIFFE** 503-D1 (128mm Bohrabstand) **ARBEITSPLATTE** 38mm, HPL, Farbe Galicia **KANTEN** Massivholz Esche, Kantenprofil №1 **AUFKANTUNG** 7mm, HPL, Farbe Galicia (Höhe 20mm) **SOCKEL** Dekorsockel #1, MDF/Eschenholz-Furnier/ Massivholz Esche, Farbe 102, Höhe 147mm **DEKORELEMENTE** Pilaster #5; untere dekorative Stütze OND-1(150/75), OND-1(150/150); obere dekorative Stütze OVD-1(150); dekorative Stütze OD-4; Kranzprofil B-3K Kombi gerade (Leiste mit glattem Design); Zierblende NM «Tellerregal» (Breite 596mm); bogenförmige Zierblende #4; gerade Balustrade (Formbaluster); Zierprofil PM-3 gerade; Dekorschrank P-15 für Dunstabzugshaube; Dekorblende BPD-6-1; Winkelpassstück NMU





MADEIRA



EN_Pilsater #5, decorative support OD-4
 DE_Pilaster #5, dekorative Stütze OD-4

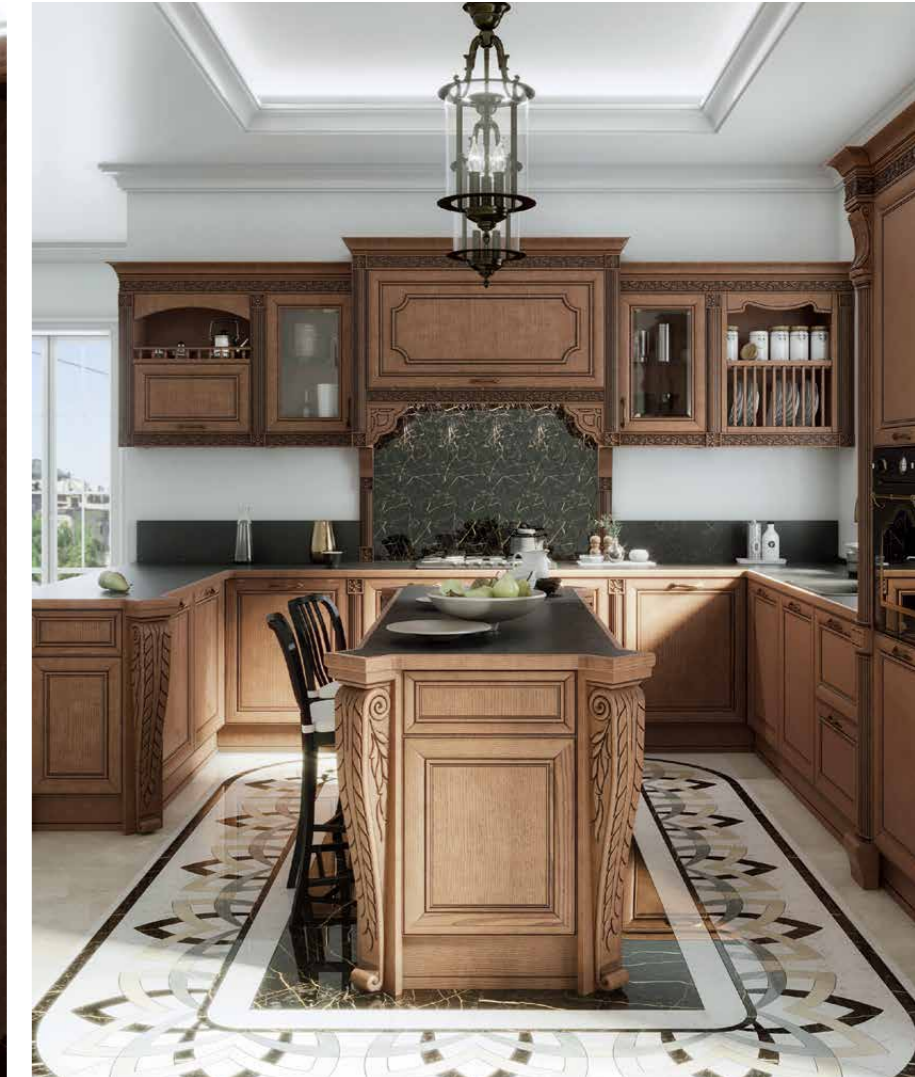

ARTWOOD

EN

FRONTS T515K Natural ash wood **FRONTS COLOR** 110 **GLASS FRONTS** Mullion glass front #2 **HANDLES/KNOBS** Porcelain Bronze (96mm hole spacing), Porcelain Bronze **WORKTOP** 38mm, HPL, color Nacarado / 60mm, solid ash wood, color #182 oil-wax finish Rosewood **WORKTOP EDGE** Solid ash wood, edge profile N°2 **PLINTH** Decorative plinth #1, MDF/ash wood veneer/solid ash wood, color 110, height 147mm **DECORATIVE ELEMENTS** Pilaster #9, lower decorative support OND-2-1, OND-2-2L/R, OND-2-3; upper decorative support OVD-2; crown moulding B-3K Combi straight (rope strip 15K); decorative elements of wood pulp (design-4); capital #3; straight balustrade (shaped balusters); pelmet PM-3 straight; wall plate rack 90; decorative panel BPD-7-2; corner filler NMU

DE

FRONTEN T515K Echtholz Esche **FRONTFARBE** 110 **GLASFRONTEN** Glasfront #2 mit Sprossen Bohrabstand), Porzellan Bronze **GRIFFE/KNÖPFE** Porzellan Bronze (96mm Bohrabstand), Porzellan Bronze **ARBEITSPLATTE** 38mm, HPL, Farbe Nacarado / 60mm, Massivholz Esche, Farbe #182 Öl-Wachs-Finish Palisander **KANTEN** Massivholz Esche, Kantenprofil N°2 **SOCKEL** Dekorsockel #1, MDF/Eschenholz-Furnier/Massivholz Esche, Farbe 110, Höhe 147mm **DEKORELEMENTE** Pilaster #9; untere dekorative Stütze OND-2-1, OND- 2-2L/R, OND-2-3; obere dekorative Stütze OVD-2; Kranzprofil B-3K Kombi gerade (Zopfleiste 15K); Dekorelemente aus Holzschliff (Ausführung-4); Kapitell #3; gerade Balustrade (Formbaluster); Zierprofil PM-3 gerade; Teller-Wandregal 90; Dekorblende BPD-7-2; Winkelpassstück NMU





ARTWOOD

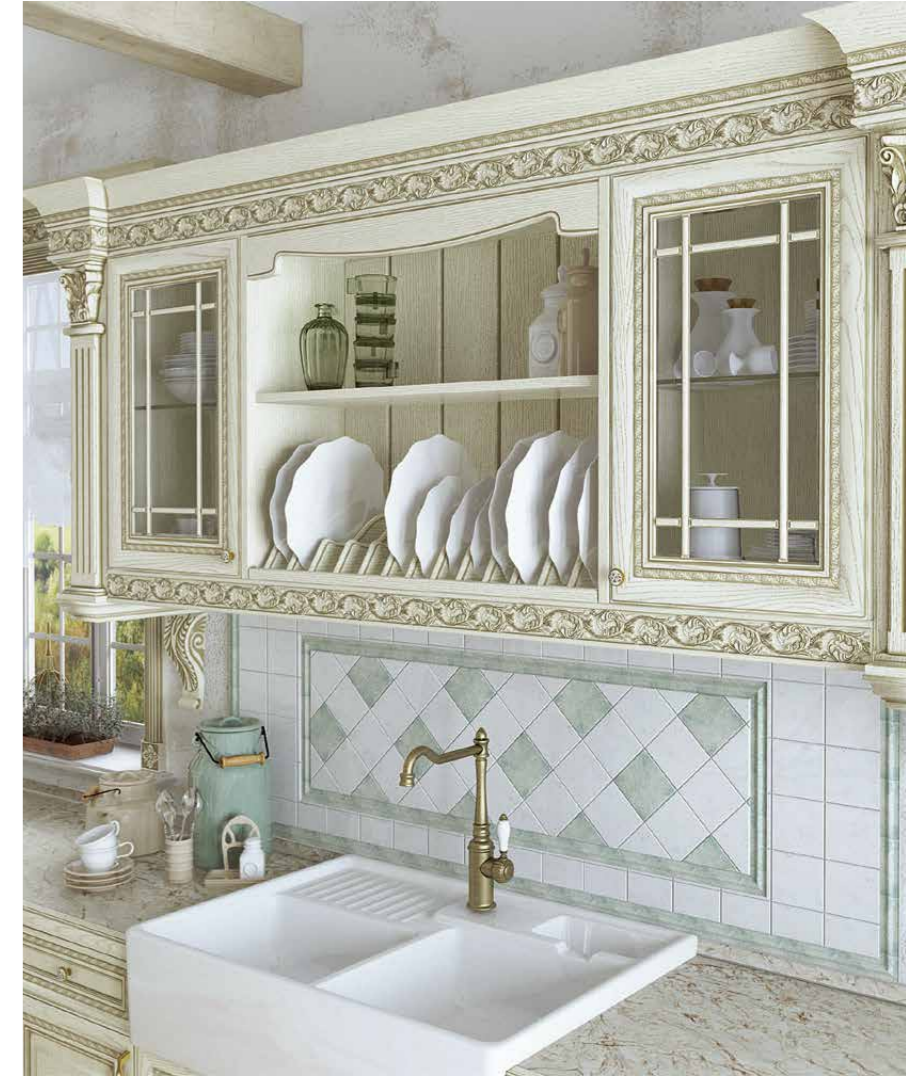

EN_Wall plate rack 90
DE_Teller-Wandregal 90

AMATO

EN

FRONTS T519 Natural ash wood **FRONTS COLOR** 110 (patina Champagne) **GLASS FRONTS** Mullion glass front #2 **HANDLES/KNOBS** Porcelain Nickel (96mm hole spacing), Porcelain Nickel **WORKTOP** 38mm, HPL, color Valmasino Marble Light Grey **WORKTOP EDGE** Solid ash wood, edge profile №1 **PLINTH** Decorative plinth #1, MDF/ash wood veneer/solid ash wood, color 110 (patina Champagne), height 147mm **DECORATIVE ELEMENTS** Pilaster #9, decorative trim NM for open shelves (713x196), valance #4, lower decorative support OND-2-1(150/192), crown moulding B-3K straight (strip in smooth design), decorative panel BPD-7-2, decorative front BPD-7-4, pelmet PM-2 straight

DE

FRONTEN T519 Echtholz Esche **FRONTFARBE** 110 (Patina Champagne) **GLASFRONTEN** Glasfront #2 mit Sprossen **GRIFFE/KNÖPFE** Porzellan Nickel (96mm Bohrabstand), Porzellan Nickel **ARBEITSPLATTE** 38mm, HPL, Farbe Marmor Valmasino Hellgrau **KANTEN** Massivholz Esche, Kantenprofil №1 **SOCKEL** Dekorsockel #1, MDF/Eschenholz-Furnier/Massivholz Esche, Farbe 110 (Patina Champagne), Höhe 147mm **DEKORELEMENTE** Pilaster #9, Zierblende NM für offene Regale (713x196), bogenförmige Zierblende #4, untere dekorative Stütze OND-2-1(150/192), Kranzprofil B-3K gerade (Leiste mit glattem Design), Dekorblende BPD-7-2, Dekorfront BPD-7-4, Zierprofil PM-2 gerade





AMATO



EN_Decorative front BPD-7-4
DE_Dekorfront BPD-7-4

SEVERINE

EN

FRONTS T520 Natural ash wood **FRONTS COLOR** 115 (without patina) / 121 **GLASS FRONTS** Mullion glass front #2 **KNOBBS** RC089-02 **WORKTOP** 12mm, ceramic, color Kankara **OPEN SHELVES** 19mm, chipboard/ash wood veneer, color 121 **PLINTH** Straight, chipboard/ash wood veneer, color 115 (without patina) / 121, height 97mm **DECORATIVE ELEMENTS** Corner filler NMU **ILLUMINATION** Corner profile HLT with LED lighting (cabinet width 900mm), LED downlight ESTELLA square

DE

FRONTEN T520 Echtholz Esche **FRONTFARBE** 115 (ohne Patina) / 121 **GLASFRONTEN** Glasfront #2 mit Sprossen **KNÖPFE** RC089-02 **ARBEITSPLATTE** 12mm, Keramik, Farbe Kankara **OFFENE REGALE** 19mm, Spanplatte/Eschenholz-Furnier, Farbe 121 **SOCKEL** Gerade, Spanplatte/Eschenholz-Furnier, Farbe 115 (ohne Patina) / 121, Höhe 97mm **DEKORELEMENTE** Winkelpassstück NMU **BELEUCHTUNG** Eckprofil HLT mit LED-Beleuchtung (Korpusbreite 900mm), LED downlight ESTELLA quadratisch





SEVERINE



EN_Corner profile HLT with LED lighting
DE_Eckprofil HLT mit LED-Beleuchtung

BARI

EN

FRONTS T536 Natural ash wood / Lacquered MDF **FRONTS COLOR** NCS S 0500-N (without patina) / NCS S 3040-Y90R Matt **DECORATIVE FRONTS** Front Combi-V2 («Loft-1» clear glass, polymer pattern Chrome / veneered MDF) **GLASS FRONTS** Mullion glass front #1, «Loft-1» clear glass (polymer pattern Chrome) **INTERIOR FINISHING (DISPLAY UNITS)** 18mm, MFC, color Oak Sonoma **HANDLES/HINGES/OPENING SYSTEMS** 777-T2 (32mm hole spacing), RC089-02, faux butt hinge WCR250-T2, strap hinge WCR100-T2, Push to open Silent, Push to open Magnet, WingLine L **WORKTOP** 38mm, HPL, color Chromix Silver **WORKTOP EDGE** ABS Chromix Silver **SPLASHBACK** Tongue and groove paneling, color #182 oil-wax finish Rosewood **PLINTH** Straight, chipboard/ash wood veneer, color NCS S 0500-N (without patina), height 147mm **DECORATIVE ELEMENTS** Corbel shelf LGP-1(600), LGP-1(450); pilaster #9

DE

FRONTEN T536 Echtholz Esche / MDF lackiert **FRONTFARBE** NCS S 0500-N (ohne Patina) / NCS S 3040-Y90R Matt **DEKORFRONTEN** Front Kombi-W2 («Loft-1» Klarglas, Polymermuster Chrom / furnierte MDF-Platte) **GLASFRONTEN** Glasfront #1 mit Sprossen, «Loft-1» Klarglas (Polymermuster Chrom) **INNENAUSFÜHRUNG (VITRINEN)** 18mm, melaminbeschichtete Spanplatte, Farbe Eiche Sonoma **GRIFFE/SCHARNIERE/ÖFFNUNGSSYSTEME** 777-T2 (32mm Bohrabstand), RC089-02, Scharnier WCR250-T2 (Imitation), Kreuzgehänge WCR100-T2, Push to open Silent, Push to open Magnet, WingLine L **ARBEITSPLATTE** 38mm, HPL, Farbe Chromix Silber **KANTEN** ABS Chromix Silber **SPRITZSCHUTZ** Profilbretter, Farbe #182 Öl-Wachs-Finish Palisander **SOCKEL** Gerade, Spanplatte/Eschenholz-Furnier, Farbe NCS S 0500-N (ohne Patina), Höhe 147mm **DEKORELEMENTE** Konsolenregal LGP-1(600), LGP-1(450); Pilaster #9





BARI



EN_WingLine L Folding door system
 DE_WingLine L Falttürsystem

LOFT LEGNO

EN

FRONTS T536 Natural ash wood **FRONTS COLOR** 120 / 137 (without patina) **DECORATIVE FRONTS** Front Combi-V1 (veneered MDF / «Loft-1» clear glass, polymer pattern Chrome), front Combi-V2 («Loft-1» clear glass, polymer pattern Chrome / veneered MDF) **GLASS FRONTS** «Loft-1» clear glass (polymer pattern Chrome), aluminum frame profile A-2 (color Terra Black) **HANDLES/HINGES** 777-T2 (32mm hole spacing), 47-01, faux butt hinge WCR250-T2, strap hinge WCR100-T2 **WORKTOP** 38mm/50mm, quartz agglomerate, color Galaxy **OPEN SHELVES** 50mm, hollow core with square edged profile, MDF/ash wood veneer, color 120 / 19mm, chipboard/ash wood veneer, color RAL 1016 Sulfur Yellow **PLINTH** Straight, chipboard/ash wood veneer, color 120, height 147mm **SHELVING SYSTEM** SmartCube **DECORATIVE ELEMENTS** Decorative larder unit LF1-2(150), decorative base cabinet LF2-1(150); decorative panel BPD-9-1(150)-1, BPD-9-1(150/720)-2, BPD-9-2-1, BPD-9-3; corbel shelf LGP-1(450), LGP-1(900), color RAL 1016 Sulfur Yellow; corner filler NMU

DE

FRONTEN T536 Echtholz Esche **FRONTFARBE** 120 / 137 (ohne Patina) **DEKORFRONTEN** Front Kombi-W1 (furnierte MDF-Platte / «Loft-1» Klarglas, Polymurmuster Chrom), Front Kombi-W2 («Loft-1» Klarglas, Polymurmuster Chrom / furnierte MDF-Platte) **GLASFRONTEN** «Loft-1» Klarglas (Polymurmuster Chrom), Aluminium-Rahmenprofil A-2 (Farbe Terra Schwarz) **GRIFFE/SCHARNIERE** 777-T2 (32mm Bohrabstand), 47-01, Scharnier WCR250-T2 (Imitation), Kreuzgehänge WCR100-T2 **ARBEITSPLATTE** 38mm/50mm, Quarzkomposit, Farbe Galaxy **OFFENE REGALE** 50mm, Hohlkernplatte mit geradem Kantenprofil, MDF/Eschenholz-Furnier, Farbe 120 / 19mm, Spanplatte/Eschenholz-Furnier, Farbe RAL 1016 Schwefelgelb **SOCKEL** Gerade, Spanplatte/Eschenholz-Furnier, Farbe 120, Höhe 147mm **REGALSYSTEM** SmartCube **DEKORELEMENTE** Dekorativer Vorratsschrank LF1-2(150), dekorativer Unterschrank LF2-1(150); Dekorblende BPD-9-1(150)-1, BPD9-1(150/720)-2, BPD-9-2-1, BPD-9-3; Konsolenregal LGP-1(450), LGP-1(900), Farbe RAL 1016 Schwefelgelb; Winkelpassstück NMU





LOFT LEGNO



EN_Strap hinge WCR100-T2
DE_Kreuzgehänge WCR100-T2



LUGANO

EN

FRONTS T537 Natural ash wood **FRONTS COLOR** 125 / 101 (without patina) **GLASS FRONTS** Without cross bars **DECORATIVE FRONTS** Front Combi-V1 (veneered MDF / glass), front Combi-G (veneered MDF / veneered MDF) **HANDLES/OPENING SYSTEMS** RC089-02, RS293-14 (160mm hole spacing), WingLine L **WORKTOP** 38mm, HPL, color Icy **WORKTOP EDGE** ABS Icy **PLINTH** Straight, chipboard/ash wood veneer, color 125, height 97mm **DECORATIVE ELEMENTS** Decorative panel BPD-9-1(100)-1, BPD-9-2-2, BPD-9-3; corbel shelf LGP-1(900); crown moulding LGB-1 straight; tongue and groove paneling (color 125)

DE

FRONTEN T537 Echtholz Esche **FRONTFARBE** 125 / 101 (ohne Patina) **GLASFRONTEN** Ohne Sprossen **DEKORFRONTEN** Front Kombi-W1 (furnierte MDF-Platte / Glas), Front Kombi-G (furnierte MDF-Platte / furnierte MDF-Platte) **GRIFFE/ÖFFNUNGSSYSTEME** RC089-02, RS293-14 (160mm Bohrabstand), WingLine L **ARBEITSPLATTE** 38mm, HPL, Farbe Icy **KANTEN** ABS Icy **SOCKEL** Gerade, Spanplatte/Eschenholz-Furnier, Farbe 125, Höhe 97mm **DEKORELEMENTE** Dekorblende BPD-9-1(100)-1, BPD-9-2-2, BPD-9-3; Konsolenregal LGP-1(900); Kranzprofil LGB-1 gerade; Profilbretter (Wandverkleidung, Farbe 125)





LUGANO



EN_WingLine L Folding door system
DE_WingLine L Falлтүrsystem

NORD

EN

FRONTS T222 Ash wood veneer **FRONTS COLOR** NCS S 8000-N **HANDLE RECESSES** KV-1/KV-2 **WORKTOP** 38mm, HPL, color Riverside **WORKTOP EDGE** ABS Riverside **WORKTOP UPSTAND** 7mm, HPL, color Riverside (height 60mm) **PLINTH** Straight, chipboard/ash wood veneer, color NCS S 8000-N, height 97mm **ACCESSORIES** Aluminum ventilation grill (60x484mm), hanging rail Groove

DE

FRONTEN T222 Eschenholz-Furnier **FRONTFARBE** NCS S 8000-N **GRIFFMULDEN** KV-1/KV-2 **ARBEITSPLATTE** 38mm, HPL, Farbe Riverside **KANTEN** ABS Riverside **AUFKANTUNG** 7mm, HPL, Farbe Riverside (Höhe 60mm) **SOCKEL** Gerade, Spanplatte/Eschenholz-Furnier, Farbe NCS S 8000-N, Höhe 97mm **ZUBEHÖR** Aluminium-Lüftungsgitter (60x484mm), Einhängeschiene Groove



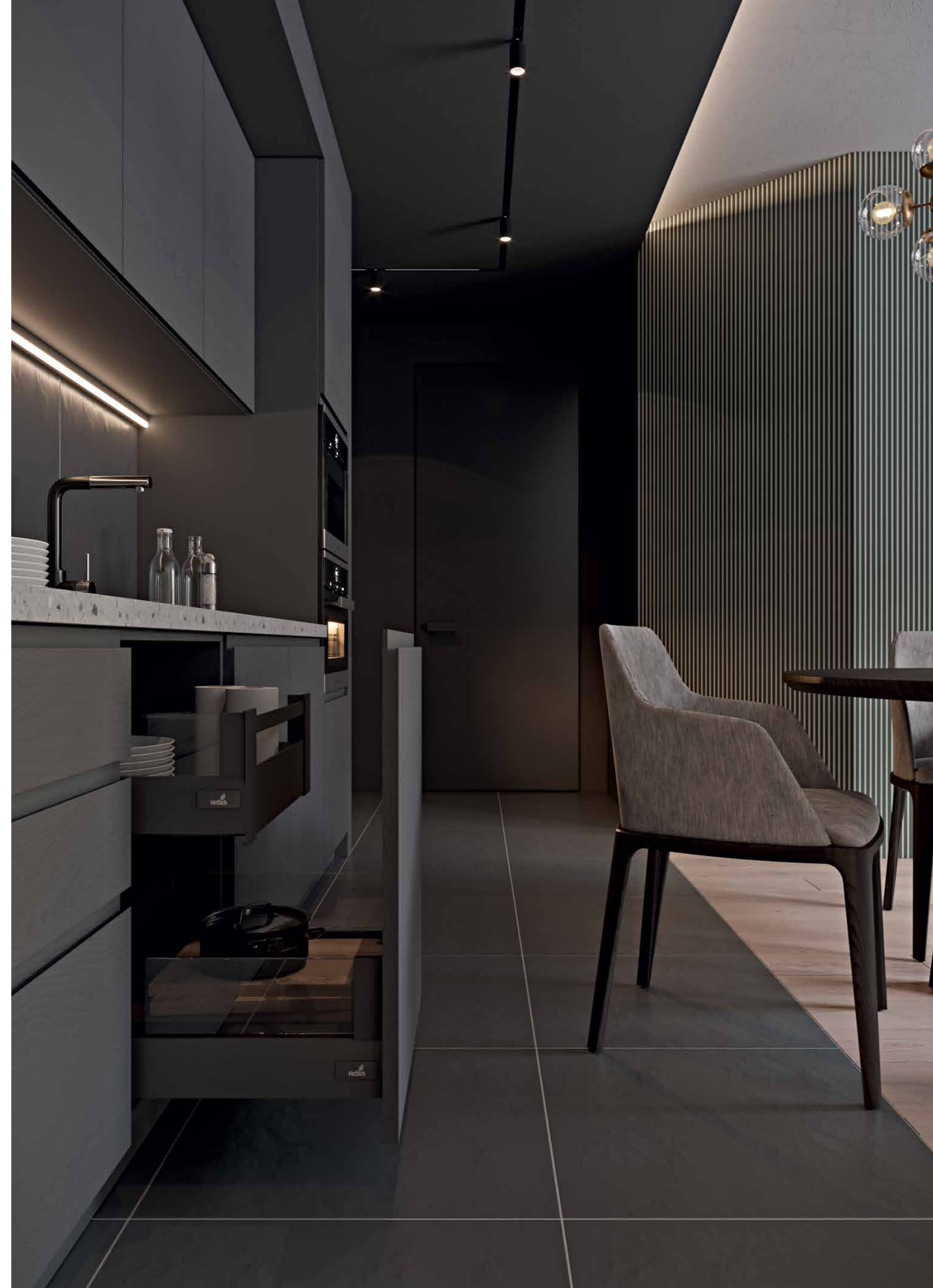

NORD



EN_Handle recess KV-2
DE_Griffmulde KV-2

SAVOIA

EN

FRONTS Ceramic **FRONTS COLOR** Savoia / Boira
WORKTOP 12mm, ceramic, color Boira **WALL**
PANEL 12mm, ceramic, color Boira **PLINTH**
 Ceramic, color Savoia / Boira, height 100mm

DE

FRONTEN Keramik **FRONTFARBE** Savoia / Boira
ARBEITSPLATTE 12mm, Keramik, Farbe Boira
WANDPANEEL 12mm, Keramik, Farbe Boira
SOCKEL Keramik, Farbe Savoia / Boira, Höhe
 100mm





SAVOIA



CENERI

EN

FRONTS Matt HPL **FRONTS COLOR** Ceneri Matt
HANDLES Profil VOLPATO Gola 80/G12 AL 09,
 Gola 80/G13 AL 09, Gola 80/G15 AL 09 **WORKTOP**
 38mm, HPL, color Ceneri / 38mm, solid ash wood,
 color #184 oil-wax finish Chestnut **WORKTOP EDGE**
 ABS Ceneri **OPEN SHELVES** 38mm, solid ash wood,
 color #184 oil-wax finish Chestnut **WALL PANEL**
 19mm, chipboard/ash wood veneer, color #184 oil-
 wax finish Chestnut **PLINTH** Matt HPL, color Ceneri
 Matt, height 100mm

DE

FRONTEN HPL matt **FRONTFARBE** Ceneri Matt
GRIFFE Profil VOLPATO Gola 80/G12 AL 09,
 Gola 80/G13 AL 09, Gola 80/G15 AL 09
ARBEITSPLATTE 38mm, HPL, Farbe Ceneri /
 38mm, Massivholz Esche, Farbe #184 Öl-Wachs-
 Finish Kastanie **KANTEN** ABS Ceneri **OFFENE**
REGALE 38mm, Massivholz Esche, Farbe #184
 Öl-Wachs-Finish Kastanie **WANDPANEEL** 19mm,
 Spanplatte/Eschenholz-Furnier, Farbe #184
 Öl-Wachs-Finish Kastanie **SOCKEL** HPL matt,
 Farbe Ceneri Matt, Höhe 100mm





CENERI



EN_Pot-and-pan drawer system ArciTech with DesignSide
DE_Frontauszug ArciTech mit DesignSide

TAUPE

EN

FRONTS Matt HPL / T219V Ash wood veneer
FRONTS COLOR Taupe Matt / #180 wax stain
 Dark **GLASS FRONTS** Clear glass (glass thickness 4mm), aluminum frame profile A-1 (color Terra Black)
DISPLAY UNITS (BACK PANEL) Lacquered MDF, color NCS S 0300-N Matt **NICHES** 19mm, lacquered MDF, color NCS S 0300-N Matt **HANDLES** Profil VOLPATO Gola 80/G12 AL 09, Gola 80/G13 AL 09
WORKTOP 38mm, HPL, color Taupe / Valmasino Marble Light Grey **WORKTOP EDGE** ABS Taupe / ABS Valmasino Marble Light Grey **PLINTH** PVC, color Black Gloss, height 100mm

DE

FRONTEN HPL matt / T219V Eschenholz-Furnier
FRONTFARBE Taupe Matt / #180 Wachsbeize
 Dunkel **GLASFRONTEN** Klarglas (Glasstärke 4mm), Aluminium-Rahmenprofil A-1 (Farbe Terra Schwarz) **VITRINEN (RÜCKWAND)** MDF lackiert, Farbe NCS S 0300-N Matt **NISCHEN** 19mm, MDF lackiert, Farbe NCS S 0300-N Matt **GRIFFE** Profil VOLPATO Gola 80/G12 AL 09, Gola 80/G13 AL 09
ARBEITSPLATTE 38mm, HPL, Farbe Taupe / Marmor Valmasino Hellgrau **KANTEN** ABS Taupe / ABS Marmor Valmasino Hellgrau **SOCKEL** PVC, Farbe Schwarz Glanz, Höhe 100mm





TAUPE



LATTERI

EN

FRONTS Matt HPL **FRONTS COLOR** Latteri Matt
GLASS FRONTS Clear glass (glass thickness 4mm), aluminum frame profile A-2 (color Champagne Brush) **WORKTOP** 38mm, HPL, color Latteri / 36mm, Synchron Varis **WORKTOP EDGE** ABS Latteri / ABS in matching color **OPEN SHELVES** 19mm, HPL, color Latteri Matt **WALL PANEL** 18mm, Synchron Varis **PLINTH** Matt HPL, color Latteri Matt, height 100mm

DE

FRONTEN HPL matt **FRONTFARBE** Latteri Matt
GLASFRONTEN Klarglas (Glasstärke 4mm), Aluminium-Rahmenprofil A-2 (Farbe Champagne Brush) **ARBEITSPLATTE** 38mm, HPL, Farbe Latteri / 36mm, Synchron Varis **KANTEN** ABS Latteri / ABS in passender Farbe **OFFENE REGALE** 19mm, HPL, Farbe Latteri Matt **WANDPANEEL** 18mm, Synchron Varis **SOCKEL** HPL matt, Farbe Latteri Matt, Höhe 100mm





LATTERI



EN_Aluminum frame profile A-2 (color Champagne Brush)
 DE_Aluminium-Rahmenprofil A-2 (Farbe Champagne Brush)

SABIA

EN

FRONTS Timber / Lacquered MDF **FRONTS COLOR** Sabia / RAL 7047 Telegrey Matt **HANDLES** Profile VOLPATO Gola 80/G12 AL 09, Gola 80/G13 AL 09 **WORKTOP** 38mm, HPL, color Chromix Anthracite **WORKTOP EDGE** ABS Chromix Anthracite **SHELVING** 19mm, lacquered MDF, color RAL 7047 Telegrey Matt **PULL-OUT UNIT** CORNERSTONE **PLINTH** PVC, color Black Gloss, height 100mm

DE

FRONTEN Timber / MDF lackiert **FRONTFARBE** Sabia / RAL 7047 Telegrau Matt **GRIFFE** Profil VOLPATO Gola 80/G12 AL 09, Gola 80/G13 AL 09 **ARBEITSPLATTE** 38mm, HPL, Farbe Chromix Anthrazit **KANTEN** ABS Chromix Anthrazit **REGALE** 19mm, MDF lackiert, Farbe RAL 7047 Telegrau Matt **AUSZUG** CORNERSTONE **SOCKEL** PVC, Farbe Schwarz Glanz, Höhe 100mm





SABIA



EN_Pull-out unit CORNERSTONE
DE_Auszug CORNERSTONE



BERINGEN

EN

FRONTS Lacquered MDF **FRONTS COLOR** NCS S 3030-R10B Matt / NCS S 7005-R80B Matt **GLASS FRONTS** Clear glass (glass thickness 4mm), aluminum frame profile A-1 (color Terra Black) **INTERIOR FINISHING (DISPLAY UNITS) / NICHES** 18mm, Smart Tundra **HANDLES** TIP-ON mechanical opening support system **WORKTOP** 38mm, HPL, color Volcano **WORKTOP EDGE** ABS Volcano **PLINTH** Lacquered MDF, color NCS S 3030-R10B Matt, height 100mm **ILLUMINATION** LED downlight BARRI round **ACCESSORIES** Aluminum ventilation grill (60x484mm) **KITCHEN APPLIANCES** Gas hob AEG HG567455VB, built-in oven AEG BER455120B

DE

FRONTEN MDF lackiert **FRONTFARBE** NCS S 3030-R10B Matt / NCS S 7005-R80B Matt **GLASFRONTEN** Klarglas (Glasstärke 4mm), Aluminium-Rahmenprofil A-1 (Farbe Terra Schwarz) **INNENAUSFÜHRUNG (VITRINEN) / NISCHEN** 18mm, Smart Tundra **GRIFFE** TIP-ON mechanische Öffnungsunterstützung **ARBEITSPLATTE** 38mm, HPL, Farbe Volcano **KANTEN** ABS Volcano **SOCKEL** MDF lackiert, Farbe NCS S 3030-R10B Matt, Höhe 100mm **BELEUCHTUNG** LED downlight BARRI rund **ZUBEHÖR** Aluminium-Lüftungsgitter (60x484mm) **KÜCHENGERÄTE** Gaskochmulde AEG HG567455VB, Einbaubackofen AEG BER455120B





BERINGEN



EN_Aluminum frame profile A-1 (color Terra Black)
 DE_Aluminium-Rahmenprofil A-1 (Farbe Terra Schwarz)



ORION

matt&glossy

EN

FRONTS Lacquered MDF **FRONTS COLOR** NCS S 3005-G50Y Matt (textured surface) / RAL 9003 Signal White Gloss **HANDLE RECESSES** KV-1/KV-2 **WORKTOP** 20mm, quartz agglomerate, color Bianco **OPEN SHELVES** 19mm, lacquered MDF, color NCS S 3005-G50Y Matt (textured surface) **PLINTH** PVC, color White Gloss, height 100mm

DE

FRONTEN MDF lackiert **FRONTFARBE** NCS S 3005-G50Y Matt (Strukturoberfläche) / RAL 9003 Signalweiß Glanz **GRIFFMULDEN** KV-1/KV-2 **ARBEITSPLATTE** 20mm, Quarzkomposit, Farbe Bianco **OFFENE REGALE** 19mm, MDF lackiert, Farbe NCS S 3005-G50Y Matt (Strukturoberfläche) **SOCKEL** PVC, Farbe Weiß Glanz, Höhe 100mm





ORION
matt&glossy



EN_Handle recesses KV-1
DE_Griffmulden KV-1

MARON

EN

FRONTS Timber / Matt glass **FRONTS COLOR** Maron / Smoky Matt **GLASS FRONTS** Clear glass Graphite (glass thickness 4mm), aluminum frame profile A-1 (color Terra Black) **INTERIOR FINISHING (DISPLAY UNITS)** 18mm, MFC, color Attic Wood **WORKTOP** 38mm, HPL, color Ceneri **WORKTOP EDGE** ABS Ceneri **BREAKFAST BAR** 40mm, MDF/PVC, color Oak Cognac Synchro **PLINTH** PVC, color Black Gloss, height 100mm

DE

FRONTEN Timber / Mattglas **FRONTFARBE** Maron / Smoky Matt **GLASFRONTEN** Klarglas Graphit (Glasstärke 4mm), Aluminium-Rahmenprofil A-1 (Farbe Terra Schwarz) **INNENAUSFÜHRUNG (VITRINEN)** 18mm, melaminbeschichtete Spanplatte, Farbe Stadlholz **ARBEITSPLATTE** 38mm, HPL, Farbe Ceneri **KANTEN** ABS Ceneri **ESSTHEKE** 40mm, MDF/PVC, Farbe Eiche Cognac Synchro **SOCKEL** PVC, Farbe Schwarz Glanz, Höhe 100mm





MARON



EN_Aluminum frame profile A-1 (color Terra Black)
 DE_Aluminium-Rahmenprofil A-1 (Farbe Terra Schwarz)

KESTEN

EN

FRONTS Timber / Acrylic **FRONTS COLOR** Kesten / Talc TopMatt **HANDLES** Profile VOLPATO Gola 80/G12 AL 09, Gola 80/G15 AL 09 **WORKTOP** 38mm, HPL, color Latteri / 38mm, solid ash wood, color #181 wax stain Walnut **WORKTOP EDGE** ABS Latteri **OPEN SHELVES** 10mm, clear glass **PULL-OUT LARDER UNIT** VS TAL Larder (HSA) **PLINTH** PVC, color Black Gloss, height 100mm **ACCESSORIES** Hanging rail Groove

DE

FRONTEN Timber / Acryl **FRONTFARBE** Kesten / Talc TopMatt **GRIFFE** Profil VOLPATO Gola 80/G12 AL 09, Gola 80/G15 AL 09 **ARBEITSPLATTE** 38mm, HPL, Farbe Latteri / 38mm, Massivholz Esche, Farbe #181 Wachsbeize Nussbaum **KANTEN** ABS Latteri **OFFENE REGALE** 10mm, Klarglas **AUSZUG** VS TAL Larder (HSA) **SOCKEL** PVC, Farbe Schwarz Glanz, Höhe 100mm **ZUBEHÖR** Einhängeschiene Groove





KESTEN



EN_Hanging rail Groove
DE_Einhängeschiene Groove



EN_Pull-out larder unit VS TAL Larder (HSA)
DE_Auszug VS TAL Larder (HSA)

PRONX

EN

FRONTS Matt glass **FRONTS COLOR** Pronx Matt / Smoky Matt **HANDLES** Profil VOLPATO Gola 80/ G12 AL 09, Gola 80/G15 AL 09, Gola 80/G14 AL 07 **WORKTOP** 38mm, HPL, color Ceramic Terra / 70mm, solid ash wood, color 126 (without patina) **WORKTOP EDGE** ABS Ceramic Terra **RACK/OPEN SHELVES** 19mm, chipboard/ash wood veneer, color 126 (without patina) / 50mm, hollow core with square edged profile, MDF/ash wood veneer, color 126 (without patina) **PLINTH** Matt glass, color Pronx Matt, height 100mm / lacquered MDF, color RAL 7016 Anthracite Grey Matt, height 100mm

DE

FRONTEN Mattglas **FRONTFARBE** Pronx Matt / Smoky Matt **GRIFFE** Profil VOLPATO Gola 80/ G12 AL 09, Gola 80/G15 AL 09, Gola 80/ G14 AL 07 **ARBEITSPLATTE** 38mm, HPL, Farbe Keramik Terra / 70mm, Massivholz Esche, Farbe 126 (ohne Patina) **KANTEN** ABS Keramik Terra **GESTELL/OFFENE REGALE** 19mm, Spanplatte/Eschenholz-Furnier, Farbe 126 (ohne Patina) / 50mm, Hohlkernplatte mit geradem Kantenprofil, MDF/Eschenholz-Furnier, Farbe 126 (ohne Patina) **SOCKEL** Mattglas, Farbe Pronx Matt, Höhe 100mm / MDF lackiert, Farbe RAL 7016 Anthrazitgrau Matt, Höhe 100mm





PRONX



SEPIA

EN

FRONTS Timber / Matt glass **FRONTS COLOR** Sepia / Pronx Matt **WORKTOP** 38mm, HPL, color Latteri / Davos Oak Truffle Brown **WORKTOP EDGE** ABS Latteri / ABS Davos Oak Truffle Brown **OPEN SHELVES** 18mm, Timber Sepia **PLINTH** PVC, color Black Gloss, height 100mm **ILLUMINATION** LED downlight LUMINO round **ACCESSORIES** Hanging rail Groove **KITCHEN APPLIANCES** Gas hob AEG HG567455VB, built-in oven AEG BER455120B

DE

FRONTEN Timber / Mattglas **FRONTFARBE** Sepia / Pronx Matt **ARBEITSPLATTE** 38mm, HPL, Farbe Latteri / Davos Eiche Trüffelbraun **KANTEN** ABS Latteri / ABS Davos Eiche Trüffelbraun **OFFENE REGALE** 18mm, Timber Sepia **SOCKEL** PVC, Farbe Schwarz Glanz, Höhe 100mm **BELEUCHTUNG** LED downlight LUMINO rund **ZUBEHÖR** Einhängeschiene Groove **KÜCHENGERÄTE** Gaskochmulde AEG HG567455VB, Einbaubackofen AEG BER455120B





SEPIA



EN_Gas hob AEG HG567455VB
 DE_Gaskochmulde AEG HG567455VB

OXIDO

EN

FRONTS Synchron / Matt HPL **FRONTS COLOR** Oxido / Latteri Matt **WORKTOP** 38mm, HPL, color Latteri **WORKTOP EDGE** ABS Latteri **SPLASHBACK** 7mm, HPL, color Latteri **PLINTH** Synchron Oxido, height 100mm **ACCESSORIES** Hanging rail Groove **KITCHEN APPLIANCES** Induction hob AEG IKK64545IB, built-in oven AEG BER455120M, built-in microwave oven AEG MBB1756D-M

DE

FRONTEN Synchron / HPL matt **FRONTFARBE** Oxido / Latteri Matt **ARBEITSPLATTE** 38mm, HPL, Farbe Latteri **KANTEN** ABS Latteri **SPRITZSCHUTZ** 7mm, HPL, Farbe Latteri **SOCKEL** Synchron Oxido, Höhe 100mm **ZUBEHÖR** Einhängeschiene Groove **KÜCHENGERÄTE** Induktionskochfeld AEG IKK64545IB, Einbaubackofen AEG BER455120M, Einbaumikrowelle AEG MBB1756D-M





OXIDO



EN_Induction hob AEG IKK64545IB
 DE_Induktionskochfeld AEG IKK64545IB

SYNCHRO DELIGHT

EN

FRONTS MDF/PVC **FRONTS COLOR** Oak Delight
 Synchro **GLASS FRONTS (TALL UNITS)** Clear
 glass (glass thickness 4mm), aluminum frame
 profile A-1 (color Terra Black) **FRAME/SHELVES**
(TALL UNITS) 19mm, HPL, color Ceneri Matt
WORKTOP 38mm, HPL, color Ceneri / Latteri
WORKTOP EDGE ABS Ceneri / ABS Latteri **PLINTH**
 Matt HPL, color Ceneri Matt, height 150mm
ACCESSORIES Hanging rail Groove

DE

FRONTEN MDF/PVC **FRONTFARBE** Eiche Delight
 Synchro **GLASFRONTEN (HOCHSCHRÄNKE)**
 Klarglas (Glasstärke 4mm), Aluminium-
 Rahmenprofil A-1 (Farbe Terra Schwarz)
KORPUSS/EINLEGEBÖDEN (HOCHSCHRÄNKE)
 19mm, HPL, Farbe Ceneri Matt **ARBEITSPLATTE**
 38mm, HPL, Farbe Ceneri / Latteri **KANTEN**
 ABS Ceneri / ABS Latteri **SOCKEL** HPL matt,
 Farbe Ceneri Matt, Höhe 150mm **ZUBEHÖR**
 Einhängeschiene Groove





SYNCHRO DELIGHT



SYNCHRO CLASSIC

EN

FRONTS MDF/PVC **FRONTS COLOR** Oak Classic Synchro **HANDLES** 0005 (width 597, 897mm) **WORKTOP** 38mm, HPL, color Icy **WORKTOP EDGE** ABS Icy **PLINTH** MDF/PVC, color Oak Classic Synchro, height 150mm **PULL-OUT STORAGE UNIT** VS TAL Gate (VSA) **DINING TABLE** Palermo, solid ash wood, color 101 (without patina), W/L/H: 740/1190/770mm

DE

FRONTEN MDF/PVC **FRONTFARBE** Eiche Klassik Synchro **GRIFFE** 0005 (Breite 597, 897mm) **ARBEITSPLATTE** 38mm, HPL, Farbe Icy **KANTEN** ABS Icy **SOCKEL** MDF/PVC, Farbe Eiche Klassik Synchro, Höhe 150mm **VORRATSSCHRANKAUSZUG** VS TAL Gate (VSA) **ESSTISCH** Palermo, Massivholz Esche, Farbe 101 (ohne Patina), B/L/H: 740/1190/770mm





SYNCHRO CLASSIC



EN_Pull-out storage unit VS TAL Gate (VSA)
 DE_Vorratsschrankauszug VS TAL Gate (VSA)

TRENT

EN

FRONTS Trent (MDF/PVC) **FRONTS COLOR** White Supermatt / RAL 5007 Brillant Blue Matt **HANDLES/ KNOBS** 47-01 (128mm hole spacing) / 47-01 **WORKTOP** 38mm, HPL, color Volcano / 38mm, KS with square edged profile, solid ash wood, color #182 oil-wax finish Rosewood **WORKTOP EDGE** ABS Volcano **NICHES** 19mm, chipboard/ash wood veneer, color #182 oil-wax finish Rosewood **PLINTH** PVC, color White Matt / Lacquered MDF, color RAL 5007 Brillant Blue Matt, height 100mm **DECORATIVE ELEMENTS** Pilaster #1, #2 **SHELVING FRAME** SmartFrame (shelves – 19mm, chipboard/ash wood veneer, color #182 oil-wax finish Rosewood, shelves width 900mm)

DE

FRONTEN Trent (MDF/PVC) **FRONTFARBE** Weiß Supermatt / RAL 5007 Brillantblau Matt **GRIFFE/KNÖPFE** 47-01 (128mm Bohrabstand) / 47-01 **ARBEITSPLATTE** 38mm, HPL, Farbe Volcano / 38mm, KS mit geradem Kantenprofil, Massivholz Esche, Farbe #182 Öl-Wachs-Finish Palisander **KANTEN** ABS Volcano **NISCHEN** 19mm, Spanplatte/Eschenholz-Furnier, Farbe #182 Öl-Wachs-Finish Palisander **SOCKEL** PVC, Farbe Weiß Matt / MDF lackiert, Farbe RAL 5007 Brillantblau Matt, Höhe 100mm **DEKORELEMENTE** Pilaster #1, #2 **REGALRAHMEN** SmartFrame (Einlegeböden – 19mm, Spanplatte/Eschenholz-Furnier, Farbe #182 Öl-Wachs-Finish Palisander, Breite der Einlegeböden 900mm)

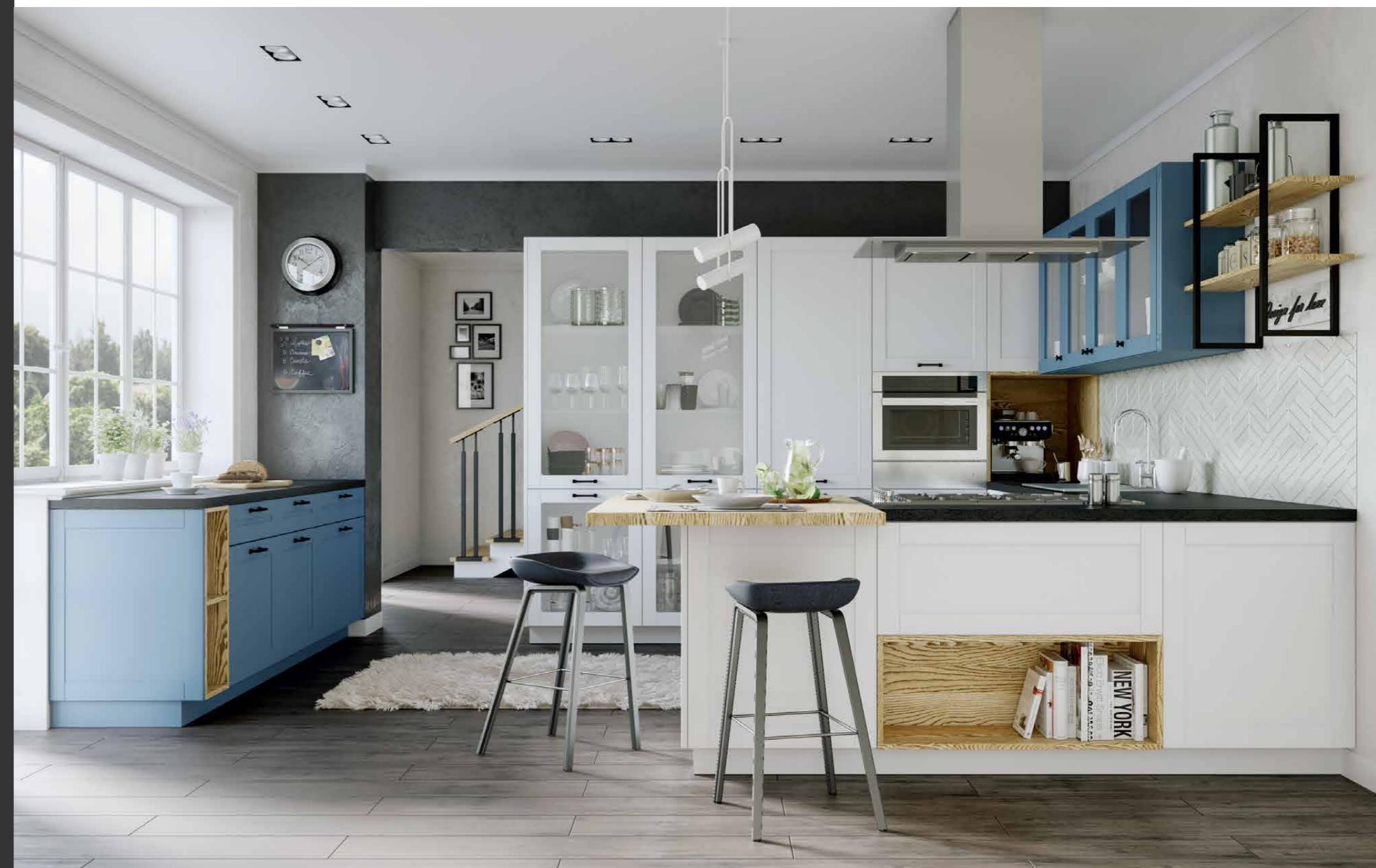



TRENT

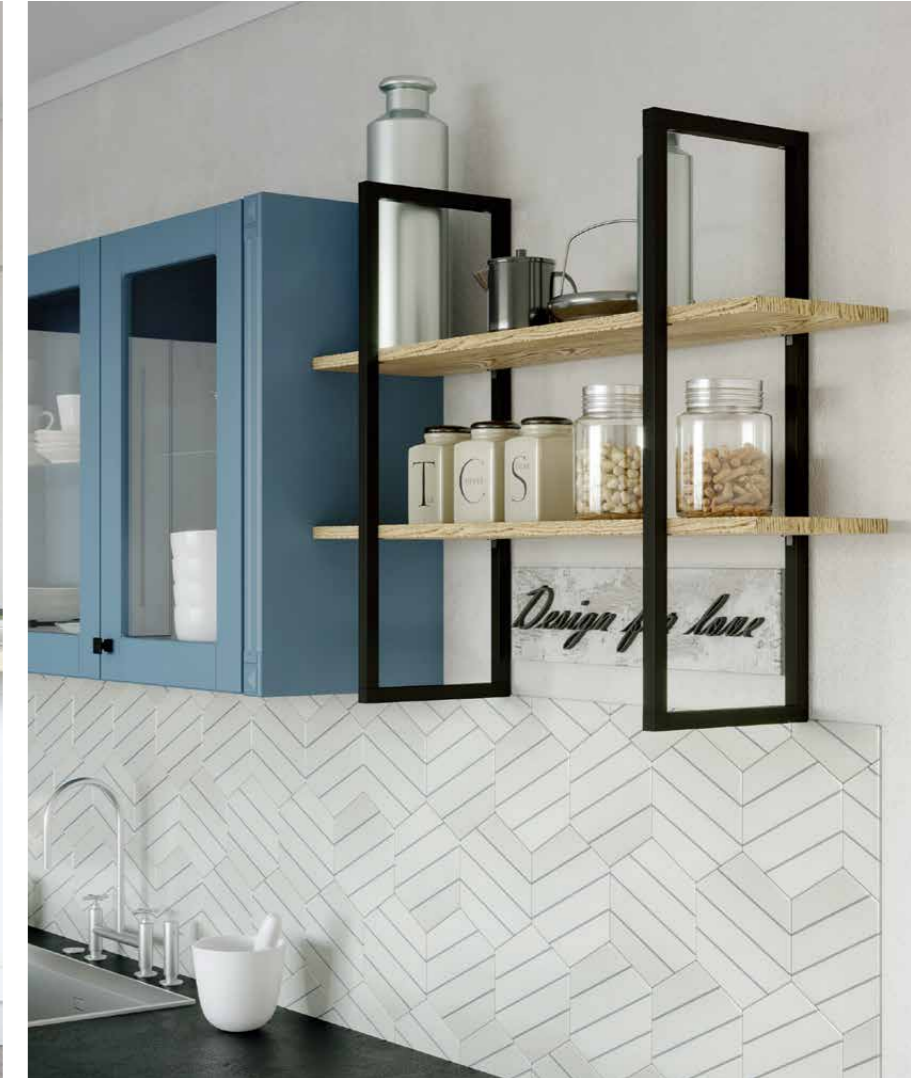

EN_Shelving frame SmartFrame
DE_Regalrahmen SmartFrame

LINNEA

EN

FRONTS Linnea (MDF/PVC) **FRONTS COLOR** Warm Grey **NICHES** 19mm, HPL, color Ceneri Matt **HANDLES** TIP-ON mechanical opening support system **WORKTOP** 38mm, HPL, color Granite Rockford **WORKTOP EDGE** ABS Granite Rockford **DINING TABLE** 38mm, HPL, color Icy **PLINTH** MDF/PVC, color Warm Grey, height 100mm **ACCESSORIES** Aluminum ventilation grill (60x484mm), hanging rail Groove **KITCHEN APPLIANCES** Induction hob AEG IKK64545IB, built-in oven AEG BER455120B

DE

FRONTEN Linnea (MDF/PVC) **FRONTFARBE** Warmes Grau **NISCHEN** 19mm, HPL, Farbe Ceneri Matt **GRIFFE** TIP-ON mechanische Öffnungsunterstützung **ARBEITSPLATTE** 38mm, HPL, Farbe Granite Rockford **KANTEN** ABS Granite Rockford **ESSTISCH** 38mm, HPL, Farbe Icy **SOCKEL** MDF/PVC, Farbe Warmes Grau, Höhe 100mm **ZUBEHÖR** Aluminium-Lüftungsgitter (60x484mm), Einhängeschiene Groove **KÜCHENGERÄTE** Induktionskochfeld AEG IKK64545IB, Einbaubackofen AEG BER455120B





LINNEA



EN_AVENTOS HK-S Small stay lift system
 DE_AVENTOS HK-S Kleine Hochklappe

LONGFORD

EN

FRONTS Longford (MDF/PVC) **FRONTS COLOR** NCS S 4502-R Matt **GLASS FRONTS** Clear glass (glass thickness 4mm) **KNOBBS** 24087.85 **WORKTOP** 38mm, HPL, color Arizona Oak Grey **WORKTOP EDGE** ABS Arizona Oak Grey **SPLASHBACK / WALL PANEL** 7mm / 19mm, HPL, color Arizona Oak Grey **PLINTH** Lacquered MDF, color NCS S 4502-R Matt, height 100mm **DECORATIVE ELEMENTS** Pilaster #4, crown moulding B-30 straight **ACCESSORIES** Hanging rail Groove **KITCHEN APPLIANCES** Induction hob ELECTROLUX IPE6443KF, built-in oven AEG BER455120M, built-in microwave oven AEG MBB1756D-M

DE

FRONTEN Longford (MDF/PVC) **FRONTFARBE** NCS S 4502-R Matt **GLASFRONTEN** Klarglas (Glasstärke 4mm) **KNÖPFE** 24087.85 **ARBEITSPLATTE** 38mm, HPL, Farbe Arizona Eiche Grau **KANTEN** ABS Arizona Eiche Grau **SPRITZSCHUTZ / WANDPANEEL** 7mm / 19mm, HPL, Farbe Arizona Eiche Grau **SOCKEL** MDF lackiert, Farbe NCS S 4502-R Matt, Höhe 100mm **DEKORELEMENTE** Pilaster #4, Kranzprofil B-30 gerade **ZUBEHÖR** Einhängeschiene Groove **KÜCHENGERÄTE** Induktionskochfeld ELECTROLUX IPE6443KF, Einbaubackofen AEG BER455120M, Einbaumikrowelle AEG MBB1756D-M





LONGFORD



HAGEN

EN

FRONTS Hagen (MDF/PVC) **FRONTS COLOR** Onyx Grey / Hickory **HANDLES** 15244.N2 (224mm hole spacing) **WORKTOP** 38mm, HPL, color Arizona Oak Grey **WORKTOP EDGE** ABS Arizona Oak Grey **SHELVING** 19mm, HPL, color Davos Oak Truffle Brown **PLINTH** MDF/PVC, color Onyx Grey, height 100mm **ACCESSORIES** Hanging rail Groove **KITCHEN APPLIANCES** Gas hob ELECTROLUX GPE263MX, built-in oven AEG BER455120B

DE

FRONTEN Hagen (MDF/PVC) **FRONTFARBE** Onyx Grau / Hickory **GRIFFE** 15244.N2 (224mm Bohrabstand) **ARBEITSPLATTE** 38mm, HPL, Farbe Arizona Eiche Grau **KANTEN** ABS Arizona Eiche Grau **REGALE** 19mm, HPL, Farbe Davos Eiche Trüffelbraun **SOCKEL** MDF/PVC, Farbe Onyx Grau, Höhe 100mm **ZUBEHÖR** Einhängeschiene Groove **KÜCHENGERÄTE** Gaskochmulde ELECTROLUX GPE263MX, Einbaubackofen AEG BER455120B





HAGEN



EN_Built-in oven AEG BER455120B
DE_Einbaubackofen AEG BER455120B



AVON AZZURRO

EN

FRONTS Avon (MDF/PVC) **FRONTS COLOR** NCS S 0500-N Matt / NCS S 2010-R80B Matt
HANDLES 11-01 (32mm hole spacing) **WORKTOP** 38mm, HPL, color Volcano **WORKTOP EDGE** ABS Volcano **OPEN SHELVING** 18mm, Timber Sabia
PLINTH Lacquered MDF, Farbe NCS S 2010-R80B Matt, height 150mm **KITCHEN APPLIANCES** Gas hob AEG HG567455VB, built-in oven AEG BER455120B

DE

FRONTEN Avon (MDF/PVC) **FRONTFARBE** NCS S 0500-N Matt / NCS S 2010-R80B Matt **GRIFFE** 11-01 (32mm Bohrabstand)
ARBEITSPLATTE 38mm, HPL, Farbe Volcano **KANTEN** ABS Volcano **OFFENE REGALE** 18mm, Timber Sabia **SOCKEL** MDF lackiert, Farbe NCS S 2010-R80B Matt, Höhe 150mm
KÜCHENGERÄTE Gaskochmulde AEG HG567455VB, Einbaubackofen AEG BER455120B





AVON AZZURRO



EN_Gas hob AEG HG567455VB
 DE_Gaskochmulde AEG HG567455VB

CLYDE

EN

FRONTS Clyde (MDF/PVC) **FRONTS COLOR** White Supermatt / Wolfram Grey **HANDLES** RC089-02 **WORKTOP** 38mm, HPL, color Kansas Oak Brown **WORKTOP EDGE** ABS Kansas Oak Brown **WALL SHELF / SHELVES (BASE UNIT)** 19mm, MDF/PVC, color Wolfram Grey / 18mm, MFC, color Premium White **WINE RACK** 18mm, MFC, color Graphite **PLINTH** MFC, color Graphite / Premium White, height 100mm **DECORATIVE ELEMENTS** Pilaster #1, crown moulding B-30 straight

DE

FRONTEN Clyde (MDF/PVC) **FRONTFARBE** Weiß Supermatt / Wolfram Grau **GRIFFE** RC089-02 **ARBEITSPLATTE** 38mm, HPL, Farbe Kansas Eiche Braun **KANTEN** ABS Kansas Eiche Braun **WANDREGAL / REGALE (UNTERSCHRANK)** 19mm, MDF/PVC, Farbe Wolfram Grau / 18mm, melaminbeschichtete Spanplatte, Farbe Premium Weiß **WEINREGAL** 18mm, melaminbeschichtete Spanplatte, Farbe Graphit **SOCKEL** Melaminbeschichtete Spanplatte, Farbe Graphit / Premium Weiß, Höhe 100mm **DEKORELEMENTE** Pilaster #1, Kranzprofil B-30 gerade





CLYDE





MATERIALS FOR
FRONTS

MATERIALIEN
FÜR FRONTEN

NATURAL ALDER WOOD

ECHTHOLZ ERLE

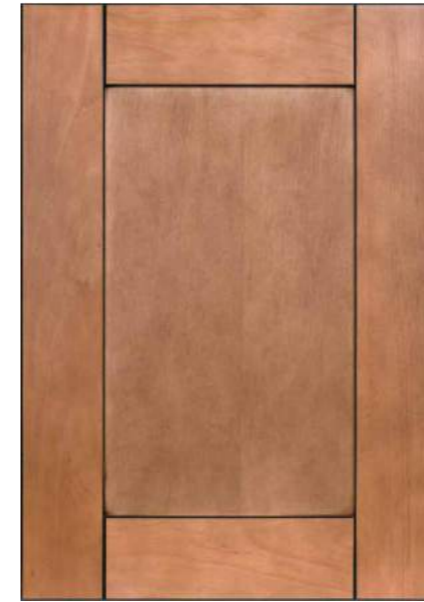

T301



T305



T306



T307



T308



T311



T314



T314K



T334

COLORS FOR FRONTS OF NATURAL ALDER WOOD

FARBEN FÜR FRONTEN AUS ERLLENHOLZ



101 beige patina
beige Patina



102 black patina
schwarze Patina



106 black patina
schwarze Patina



109 black patina
schwarze Patina



110 beige patina
beige Patina



110 Patina
Champagne



112 patina X109
Patina X109



112 ginger patina
rötliche Patina



113 black patina
schwarze Patina



115 gold patina
goldene Patina



116 gold patina
goldene Patina



117 beige patina
beige Patina



118 silver patina
silberne Patina



120



121



122 white patina
weiße Patina



131 chocolate patina
schokoladenbraune
Patina



132 chocolate patina
schokoladenbraune
Patina

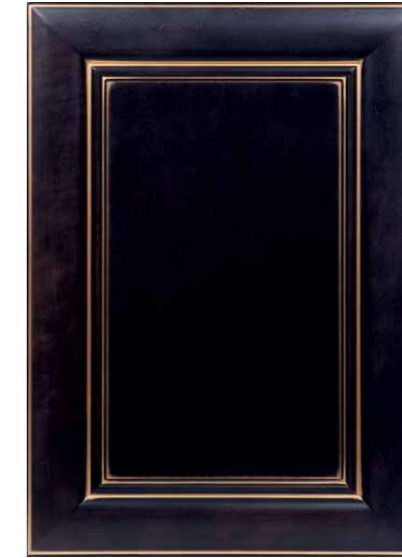

133 gold patina
goldene Patina



134 black patina
schwarze Patina



123 black patina
schwarze Patina



124



125



126 gold patina
goldene Patina



135 (F167) patina Graphite
Patina Graphit



136 (S052) patina X109
136 (S052) Patina X109



137 (N031) gold patina, glossy varnish 50
137 (N031) goldene Patina, Glanzlack 50



127 black patina
schwarze Patina



128 black patina
schwarze Patina



129 silver patina
silberne Patina



130 black patina
schwarze Patina

Patina in all the available colors can be applied on any front / decorative element on request.
Auf Anfrage kann Patina in allen verfügbaren Farben auf jede Front / jedes Dekorelement aufgetragen werden.

NATURAL ASH WOOD

ECHTHOLZ ESCH



T501



T502



T504



T505



T506



T507



T508



T509



T511



T512



T514



T514K



T515K



T516



T518



T518K



T534



T535K



T536



T537



T519



T520



T522K



T524K



T527



T531



T532



T533

NATURAL OAK WOOD
ECHTHOLZ EICHE



T732



T736



T737

COLORS FOR FRONTS OF NATURAL ASH/OAK WOOD

FARBEN FÜR FRONTEN AUS ESCHEN-/EICHENHOLZ



101 beige patina
beige Patina



102 black patina
schwarze Patina



106 black patina
schwarze Patina



109 black patina
schwarze Patina



110 beige patina
beige Patina



110 Patina
Champagne



111 black patina
schwarze Patina



112 ginger patina
rötliche Patina



112 patina X109
Patina X109



113 black patina
schwarze Patina



114 silver patina
silberne Patina



115 gold patina
goldene Patina

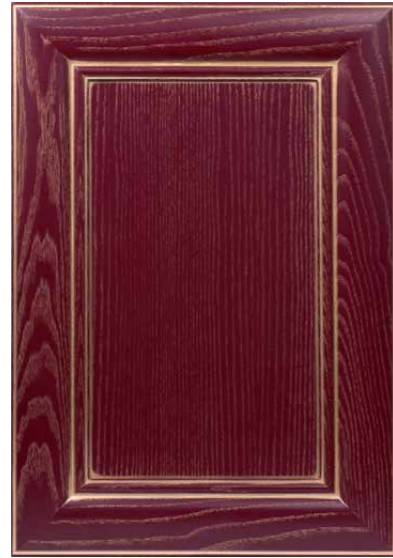

116 gold patina
goldene Patina



117 beige patina
beige Patina



118 silver patina
silberne Patina



120



129 silver patina
silberne Patina



130 black patina
schwarze Patina



131 chocolate patina
schokoladenbraune
Patina



132 chocolate patina
schokoladenbraune
Patina



121

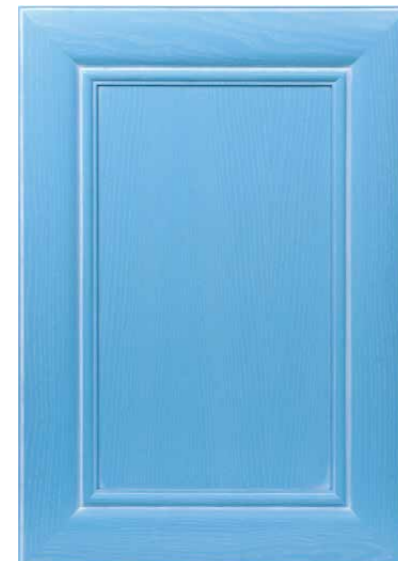

122 white patina
weiße Patina



123 black patina
schwarze Patina



124



133 gold patina
goldene Patina



134 black patina
schwarze Patina



135 (F167) patina Graphite
Patina Graphit



136 (S052) patina X109
136 (S052) Patina X109



125

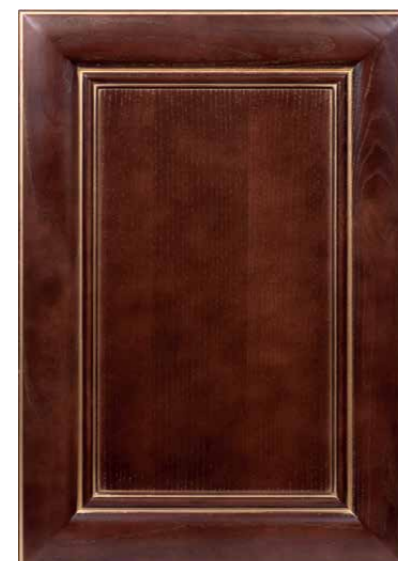

126 gold patina
goldene Patina



127 black patina
schwarze Patina



128 black patina
schwarze Patina



137 (N031) gold patina, glossy varnish 50
137 (N031) goldene Patina, Glanzlack 50

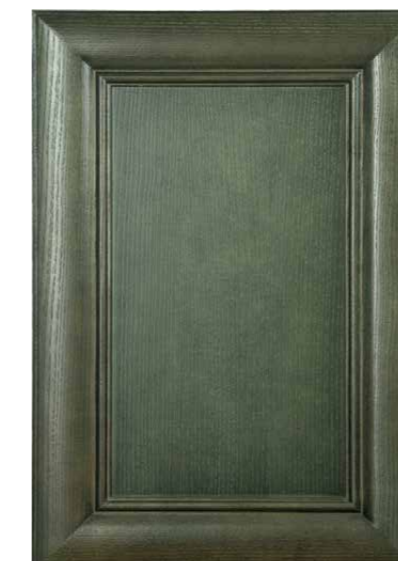

139



140 (only for fronts of oak wood)
140 (nur für Fronten aus Eiche)

Patina in all the available colors can be applied on any front / decorative element on request.

Auf Anfrage kann Patina in allen verfügbaren Farben auf jede Front / jedes Dekorelement aufgetragen werden.

ASH WOOD VENEER ESCHENHOLZ-FURNIER



T219B / T220B
T219V / T220V



T219Г / T220Г
T219G / T220G



T221B T221V



T221B T221V



T221Г T221G



T221Г T221G



T222



T222

OAK WOOD VENEER EICHENHOLZ-FURNIER



T419B / T420B
T419V / T420V



T419Г / T420Г
T419G / T420G



T421B T421V



T421B T421V



T421Г T421G



T421Г T421G



T422



T422

WAX STAINS, OIL-WAX FINISHES WACHSBEIZEN, ÖL-WACHS-FINISHS

#180 Wax stain Dark
#180 Wachsbeize Dunkel

Ash / oak
Esche / Eiche



#181 Wax stain Walnut
#181 Wachsbeize Nussbaum

Ash / oak
Esche / Eiche



#182 Oil-wax finish Rosewood
#182 Öl-Wachs-Finish Palisander

Ash / oak
Esche / Eiche



#183 Oil-wax finish Clear
#183 Öl-Wachs-Finish Klar

Ash / oak
Esche / Eiche



#184 Oil-wax finish Chestnut
#184 Öl-Wachs-Finish Kastanie



Ash / oak
Esche / Eiche

#185 Oil-wax finish Hazelnut
#185 Öl-Wachs-Finish Haselnuss



Ясень / дуб
Ash / oak
Esche / Eiche

#186 Oil-wax finish Oak Wenge
#186 Öl-Wachs-Finish Eiche Wenge



Ash / oak
Esche / Eiche

#187 Oil-wax finish Fumed Oak
#187 Öl-Wachs-Finish Wassereiche



Ash / oak
Esche / Eiche

#188 Oil-wax finish Cherry tree
#188 Öl-Wachs-Finish Kirschbaum



Ash / oak
Esche / Eiche

#189 Wax stain White
#189 Wachsbeize Weiß



Oak
Eiche

#189 Wax stain White
#189 Wachsbeize Weiß



Ash
Esche

TIMBER DECORATIVE PANELS

DEKORPLATTEN TIMBER

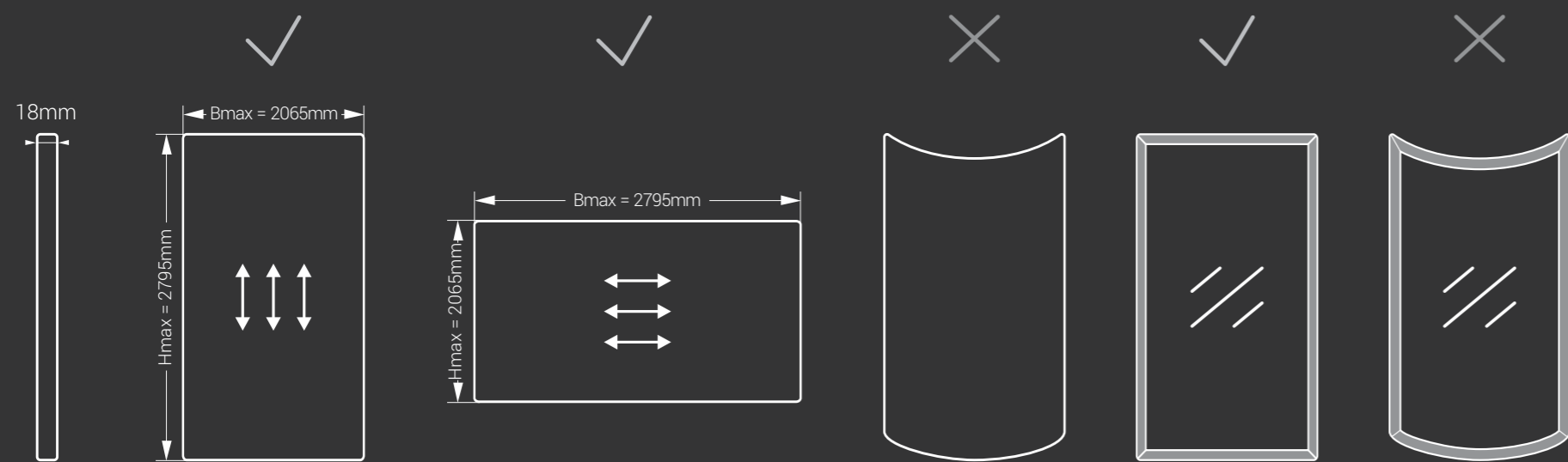

MFC
Melaminbeschichtete Spanplatte

EN

ABS edgeband in matching color
Concealed pull grips C-1, C-2, C-3 available

DE

ABS-Kante in passender Farbe
Verdeckte Griffleisten C-1, C-2, C-3 verfügbar



Albus



Sabia



Roca Roka



Texture on front and back side
Struktur auf Vorder- und Rückseite



Atic Atik



Halifax



Maron



Sepia



Kesten



Kiaro



Texture on front and back side
Struktur auf Vorder- und Rückseite



Texture on front and back side
Struktur auf Vorder- und Rückseite

SYNCRON DECORATIVE PANELS

DEKORPLATTEN SYNCRON

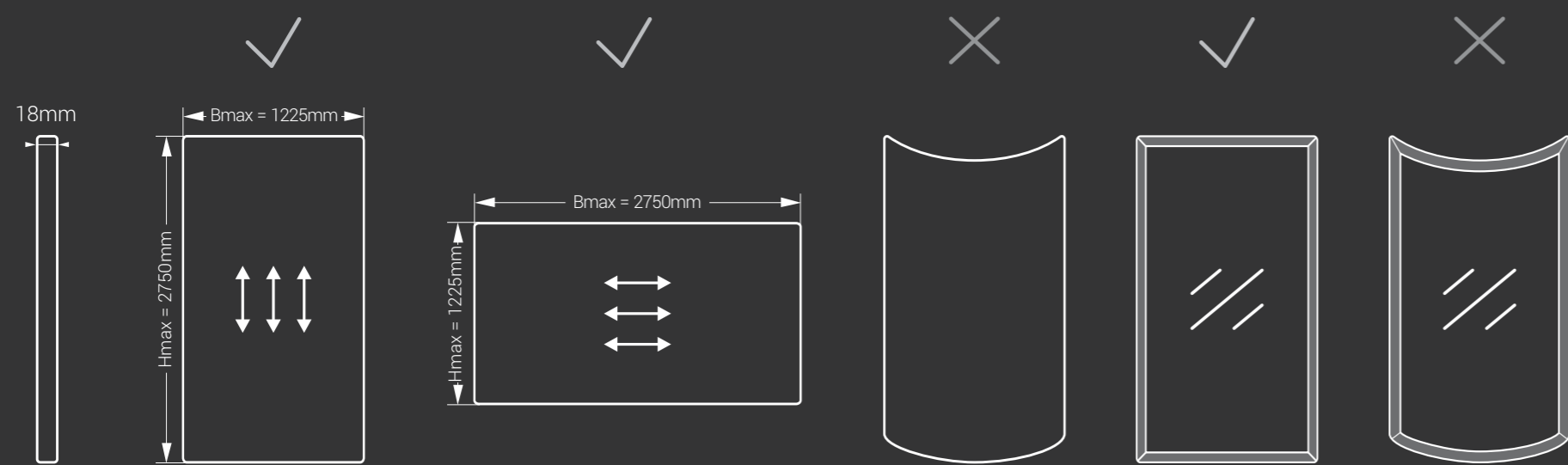

MFC
Melaminbeschichtete Spanplatte

EN

ABS edgeband in matching color, ABS Aluminium, 3D edgebands (3D Silver, 3D Bronze, 3D Plywood)
Concealed pull grips C-1, C-2, C-3 available
The front and back side have the same pattern. However the panel backside has no texture

DE

ABS-Kante in passender Farbe, ABS Aluminium, 3D-Kanten (3D Silber, 3D Bronze, 3D Furnier)
Verdeckte Griffleisten C-1, C-2, C-3 verfügbar
Die Vorder- und Rückseite haben das gleiche Dekor. Die Rückseite hat aber keine Struktur



Argento



Titanio



Oxido



Texture on front side
Struktur auf Vorderseite



Polvere



Caneli Kaneli



Agasi
Agassi



Piena



Блабер Blaber



Preto



Texture on front side
Struktur auf Vorderseite



Texture on front side
Struktur auf Vorderseite



Rosa
Rossa



Cilantro

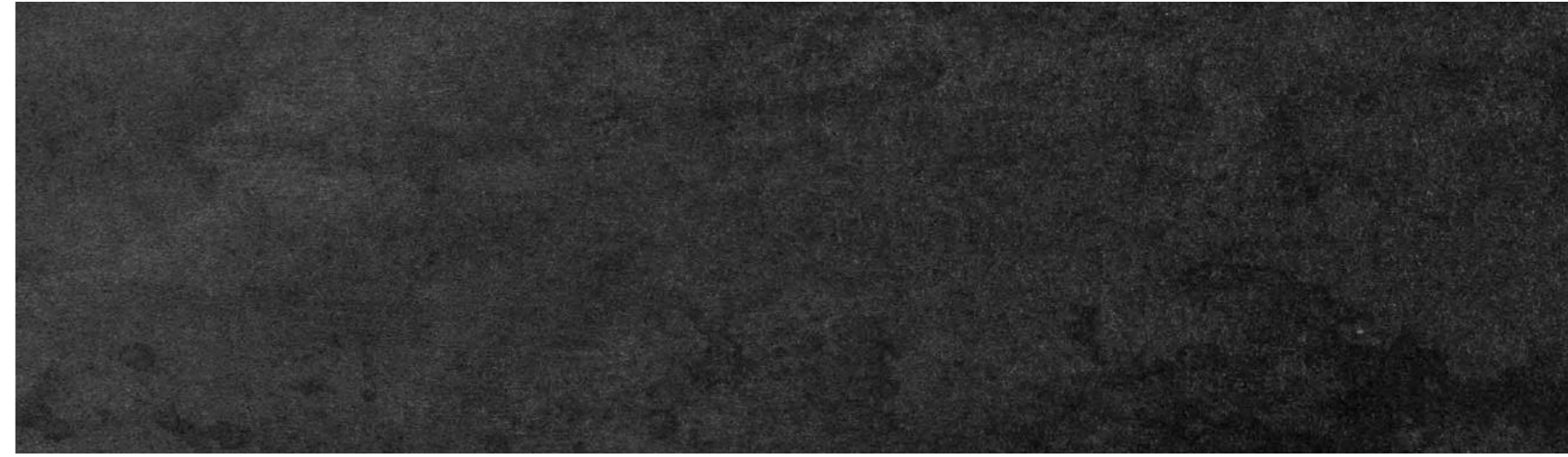

Plata

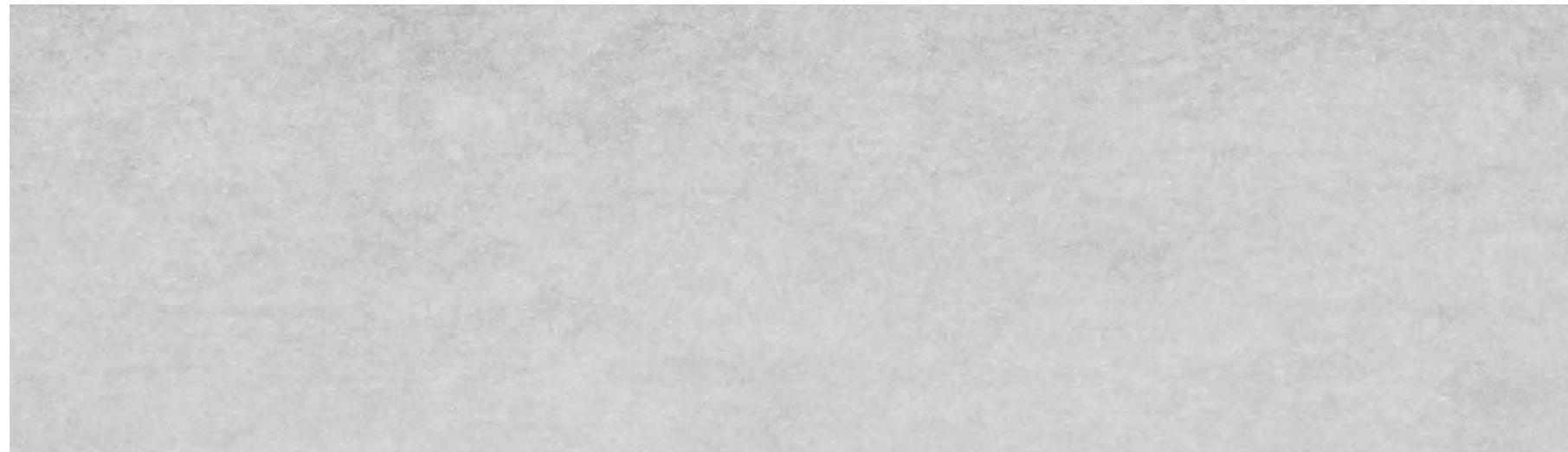

Pared

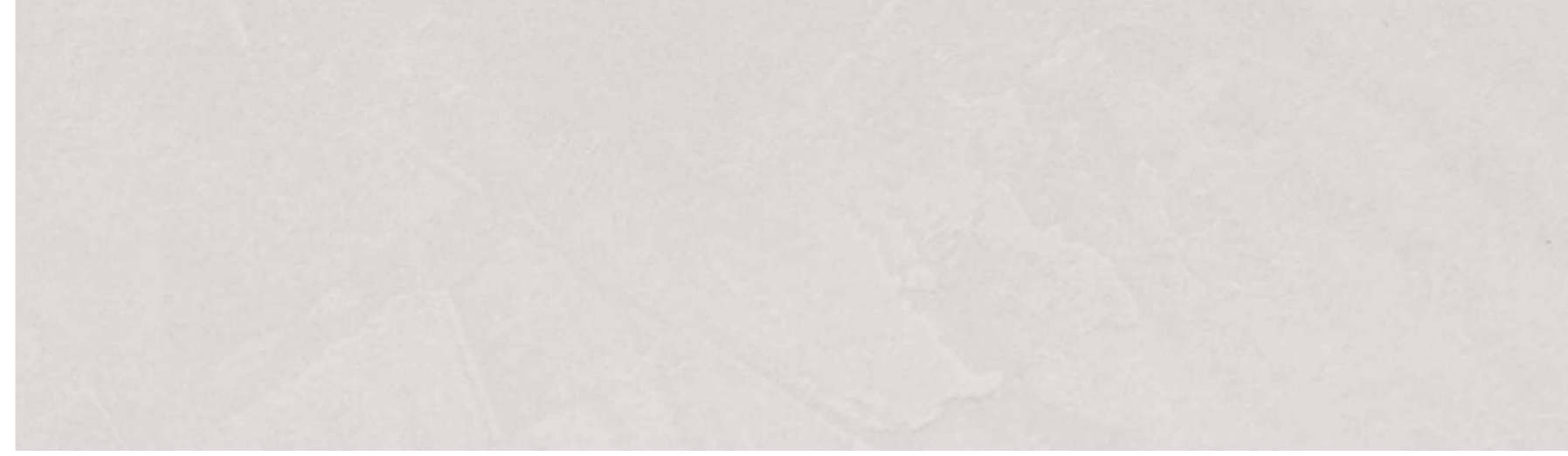

Varis
Waris



Muro

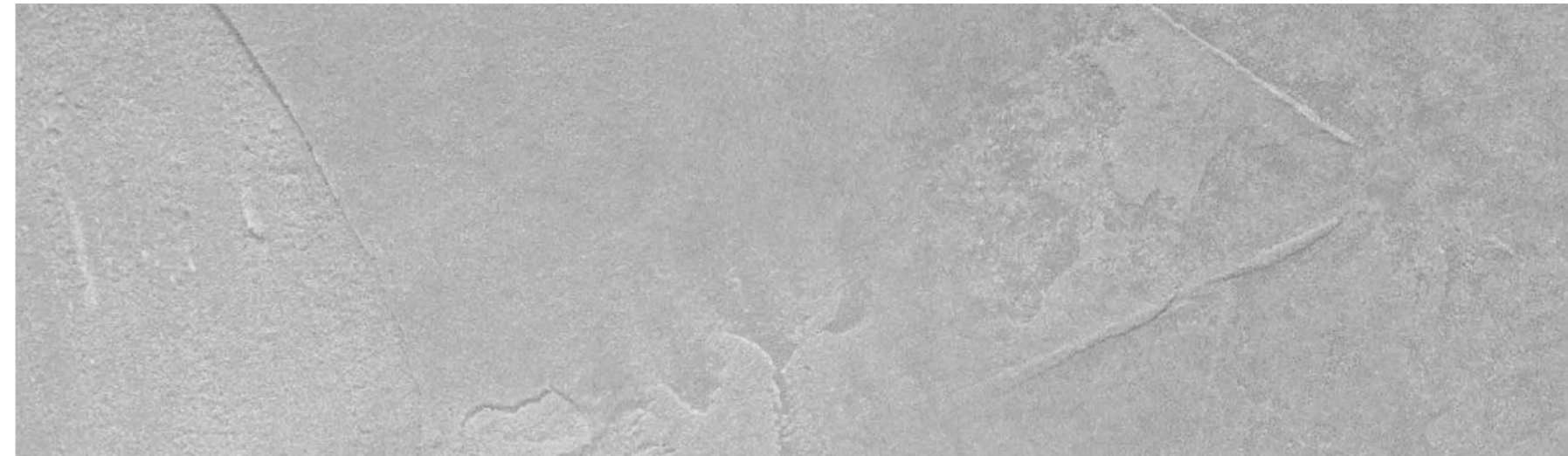

Texture on front side
Struktur auf Vorderseite



Texture on front side
Struktur auf Vorderseite

SMART DECORATIVE PANELS

DEKORPLATTEN SMART

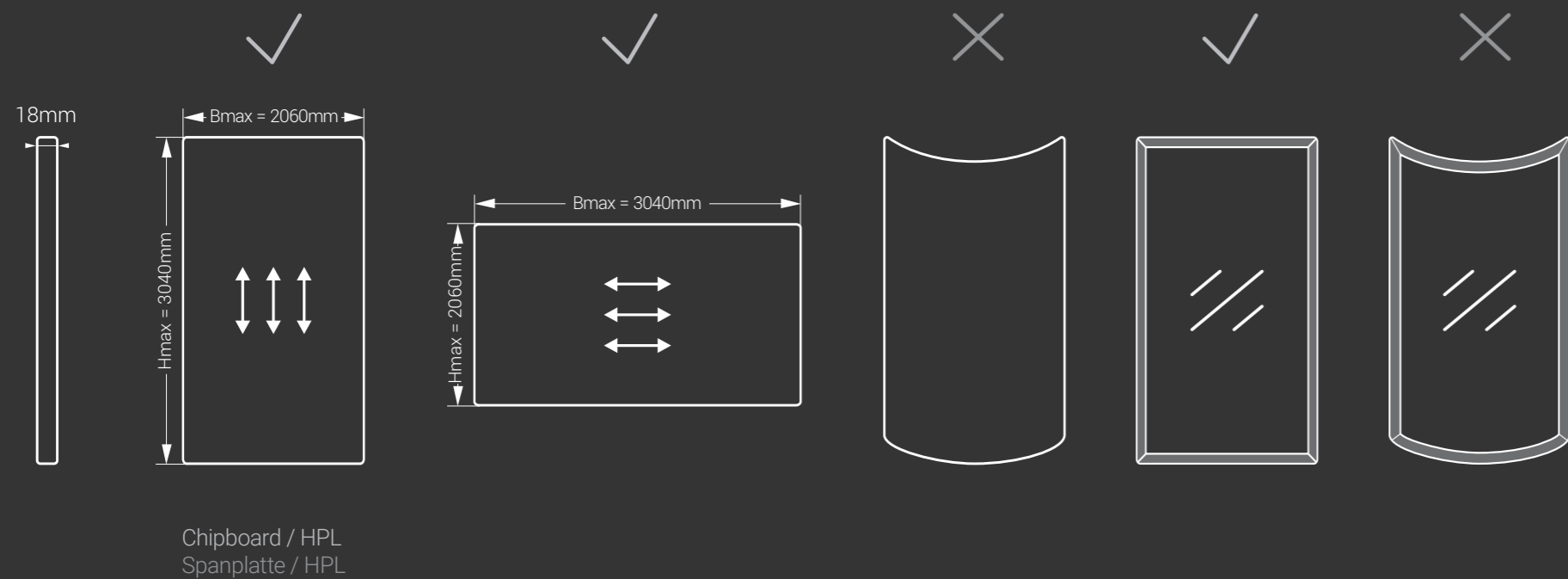

EN

ABS edgeband in matching color, ABS Aluminium,
3D edgebands (3D Silver, 3D Bronze, 3D Plywood)
Concealed pull grips C-1, C-2, C-3 available

DE

ABS-Kante in passender Farbe, ABS Aluminium,
3D-Kanten (3D Silber, 3D Bronze, 3D Furnier)
Verdeckte Griffleisten C-1, C-2, C-3 verfügbar



Platinum Platin



Nickel



Zinc Zink



Ferrum



Texture on front and back side
Struktur auf Vorder- und Rückseite



avana Savanne



Patagonia
Patagonien



Tundra



Pampas



Texture on front and back side
Struktur auf Vorder- und Rückseite



Aphrodite

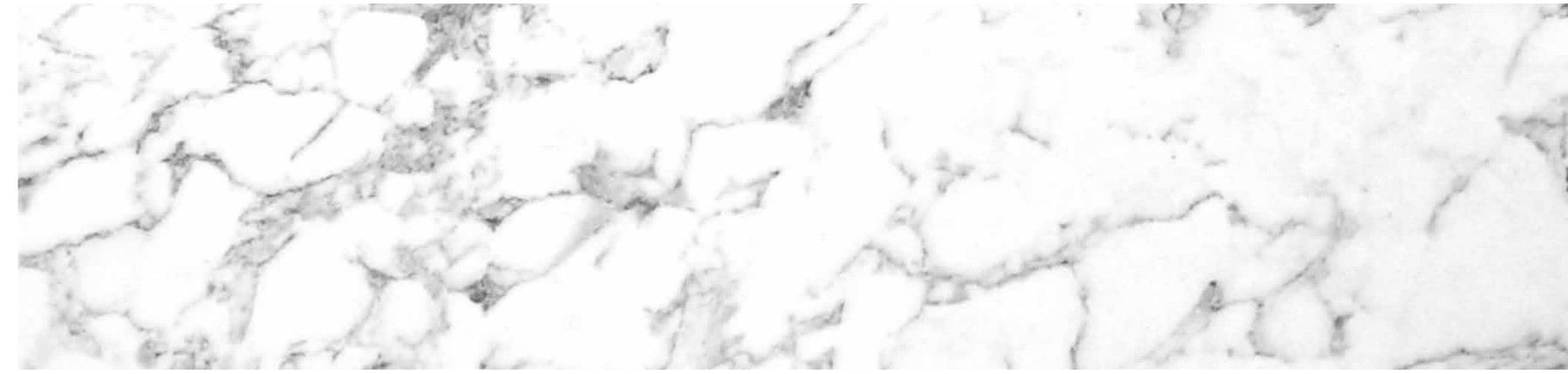

Zeus

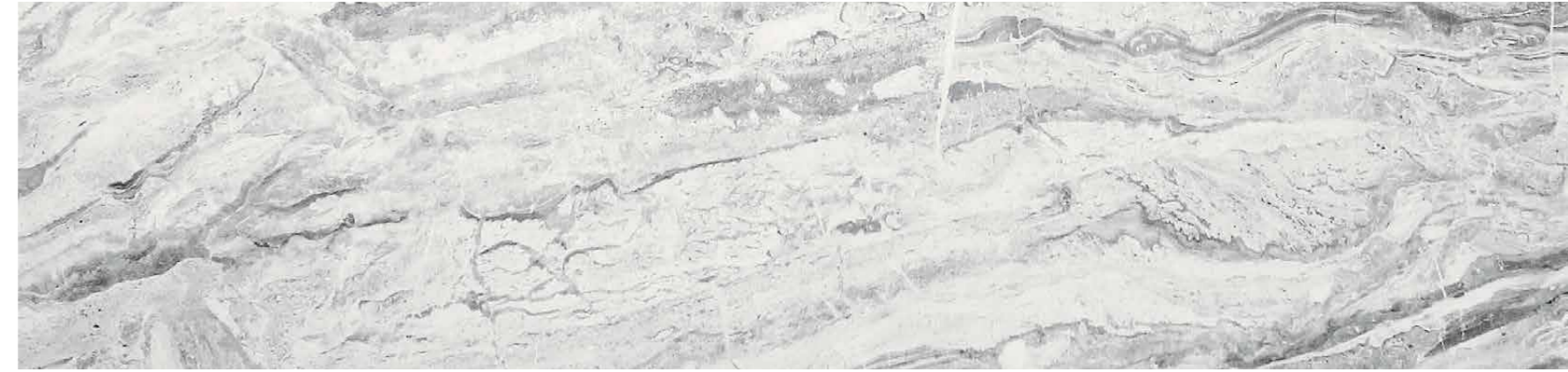

Athena



Texture on front and back side
Struktur auf Vorder- und Rückseite

CERAMIC KERAMIK

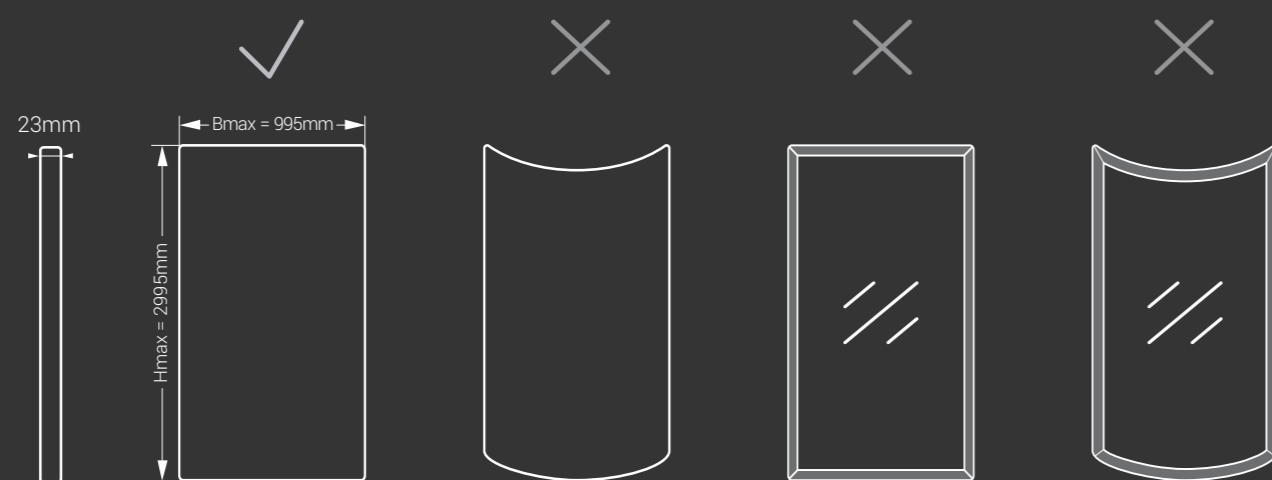

EN

ABS edgeband in matching color
1,3mm thick HPL in matching color is applied on the backside of front
Pull grips C-1, C-2, C-3 are not available
Regular handles / Push to open (Tip-On) available
The minimum front size 130x296mm

DE

ABS-Kante in passender Farbe
1,3mm starkes HPL in passender Farbe wird auf die Rückseite der Front aufgebracht
Griffleisten C-1, C-2, C-3 sind nicht möglich
Standardgriffe / Push to open (Tip-On) möglich
Die minimale Frontgröße 130x296mm

Kankara



Savoia



Boira



Vilma
Wilma



Foketa

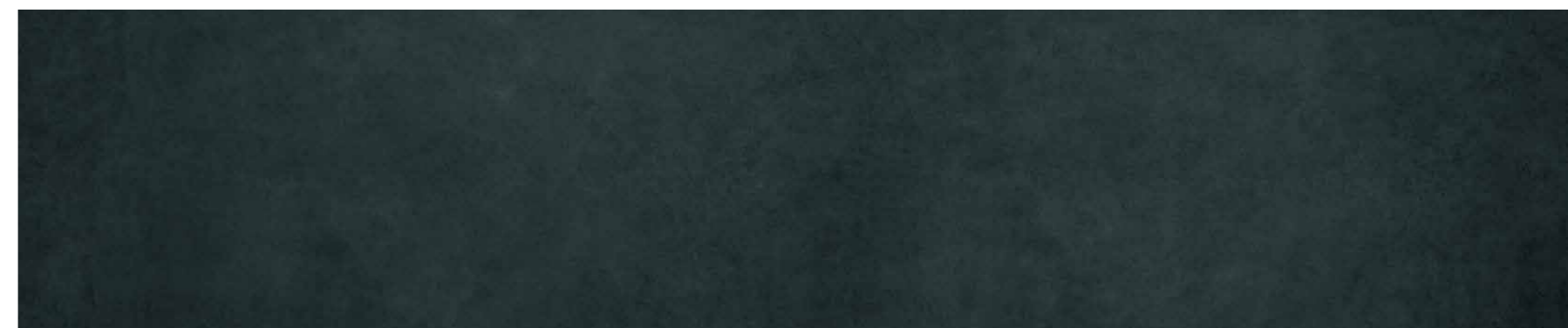

ACRYLIC ACRYL

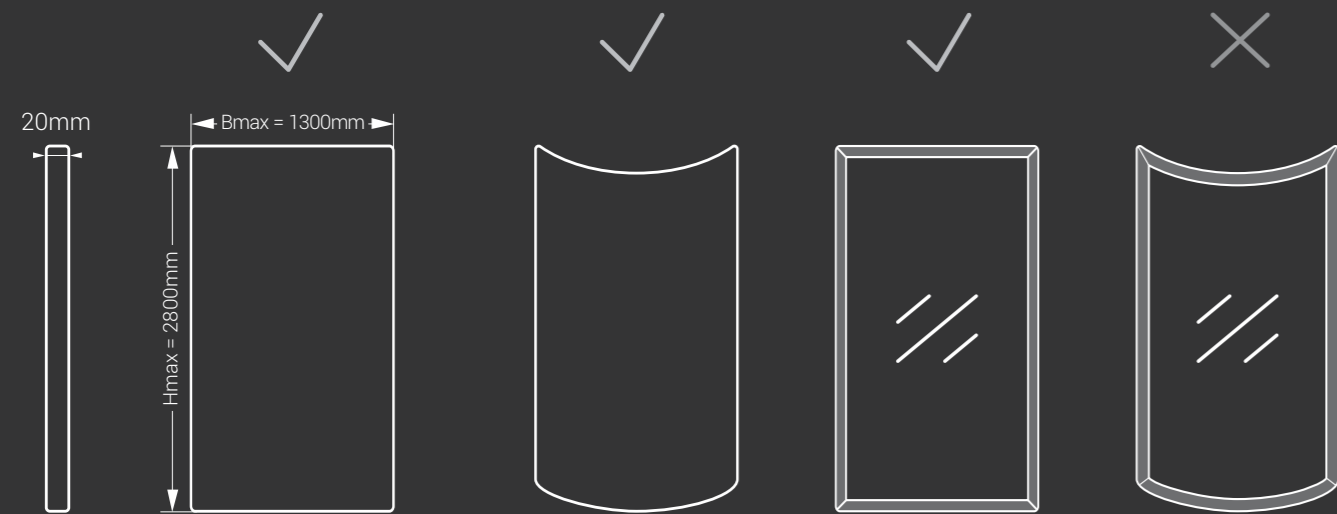

MDF base material
MDF-Trägerplatte

EN

ABS edgeband in matching color, ABS Aluminium,
3D edgebands (3D Silver, 3D Bronze, 3D Plywood)

DE

ABS-Kante in passender Farbe, ABS Aluminium,
3D-Kanten (3D Silber, 3D Bronze, 3D Furnier)

White TopMatt
Weiß TopMatt



Cream TopMatt
Sahne TopMatt

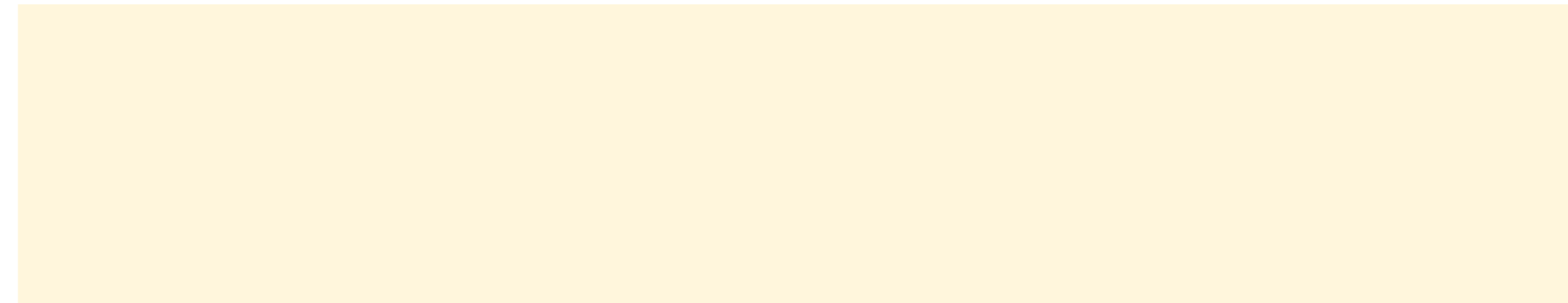

Cocoa TopMatt
Kakao TopMatt



Talc TopMatt
Talk TopMatt

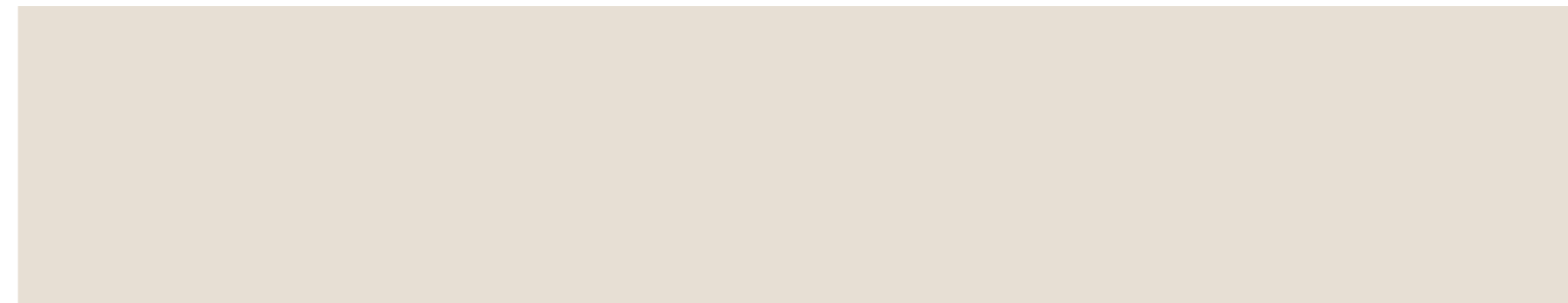

Ashes TopMatt
Asche TopMatt



Vinyl TopMatt



White* Weiß*

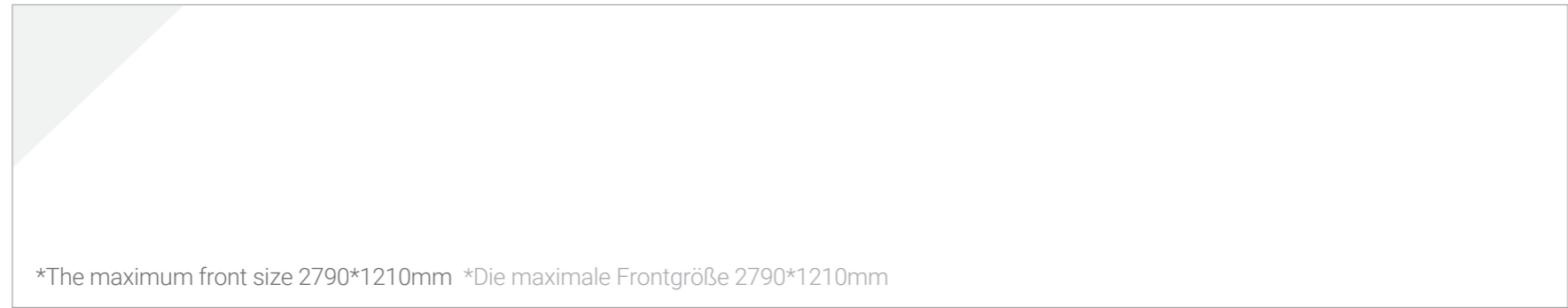

Sugar
Zucker

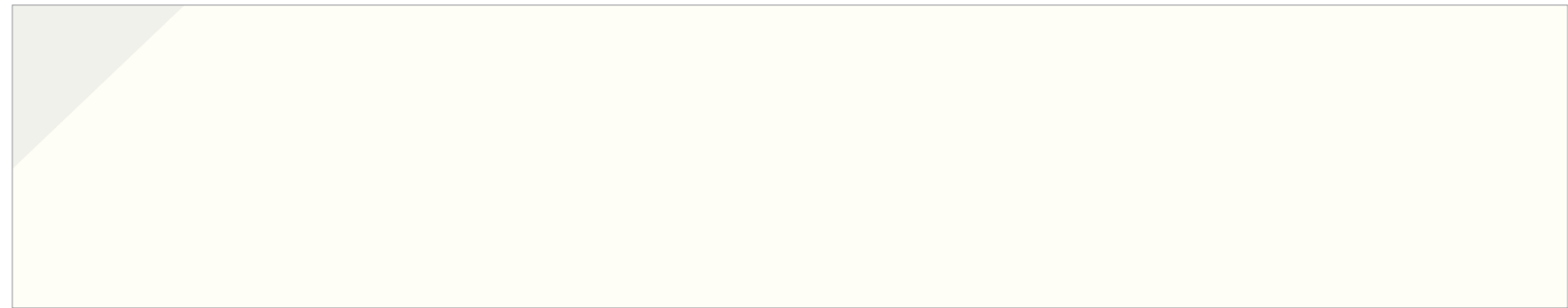

Cream Sahne

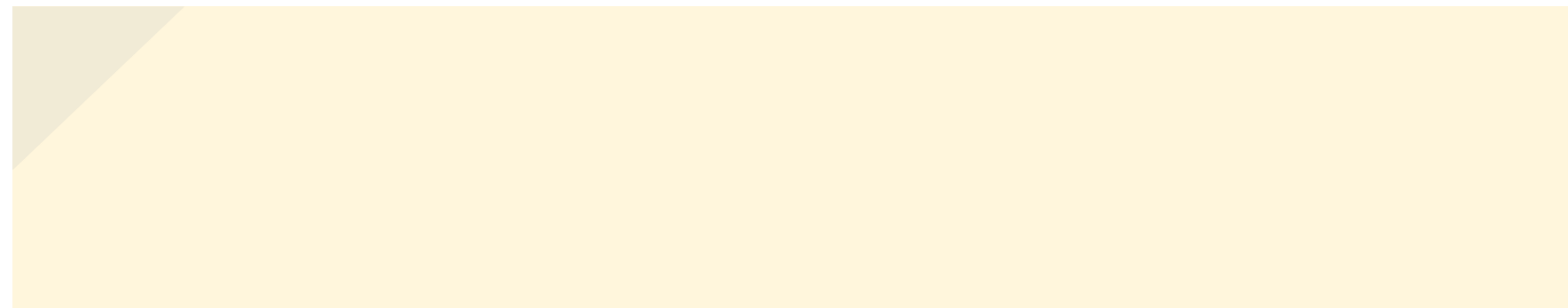

Cocoa
Kakao



Talc Talk

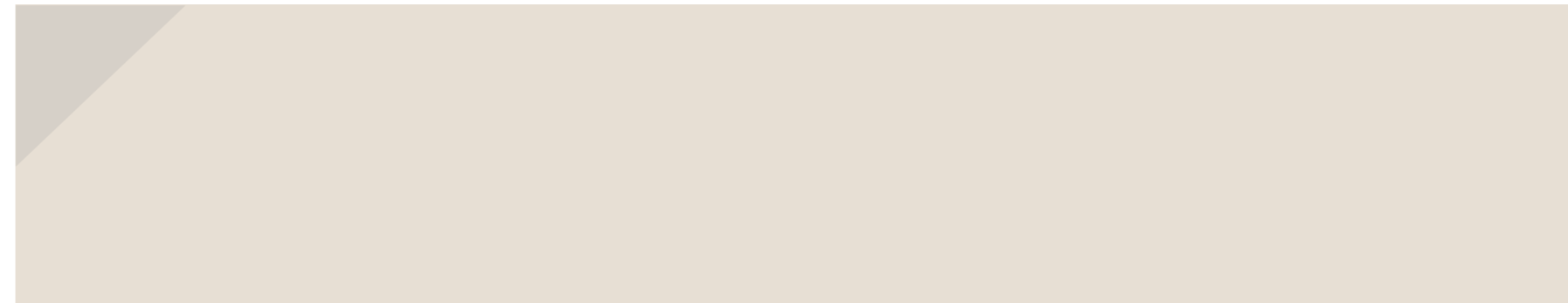

Ashes
Asche



Light Grey
Hellgrau

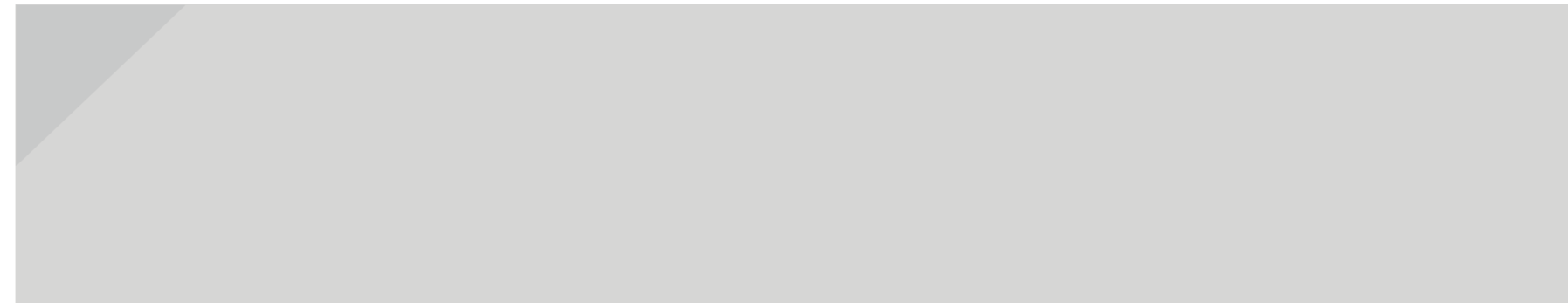

Graphite Graphit



Vinyl

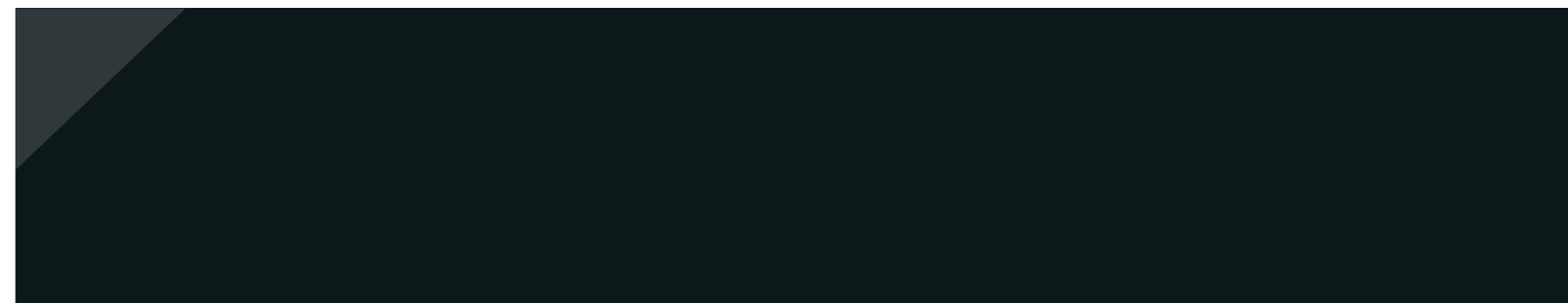

Pomegranate
Granatapfel



Blackberry
Brombeere



White Metallic
Weiß Metallic

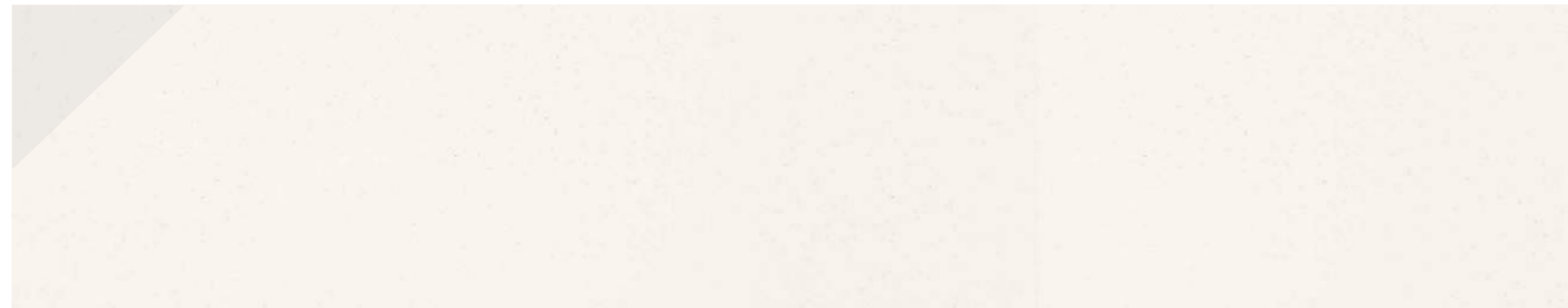

Champagne
Metallic



Steel Metallic
Stahl Metallic

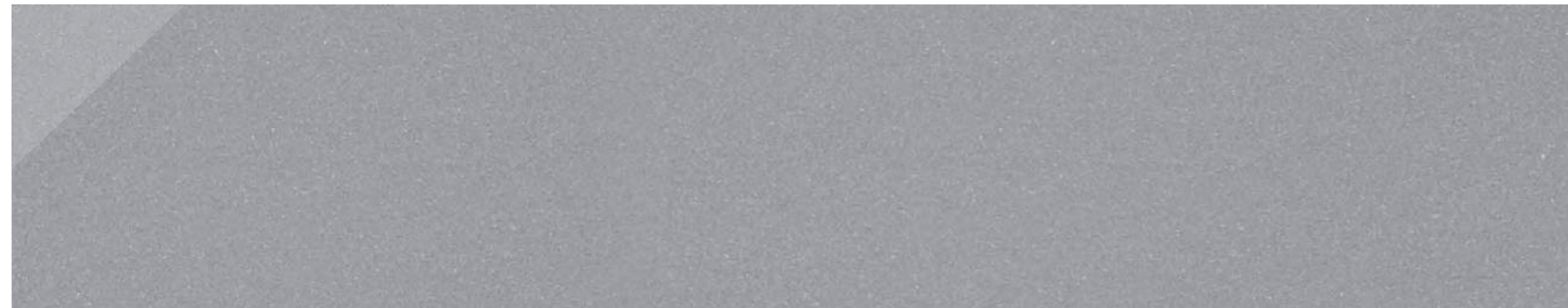

Slate Metallic Griffel
Metallic



Carbon Metallic
Kohle Metallic

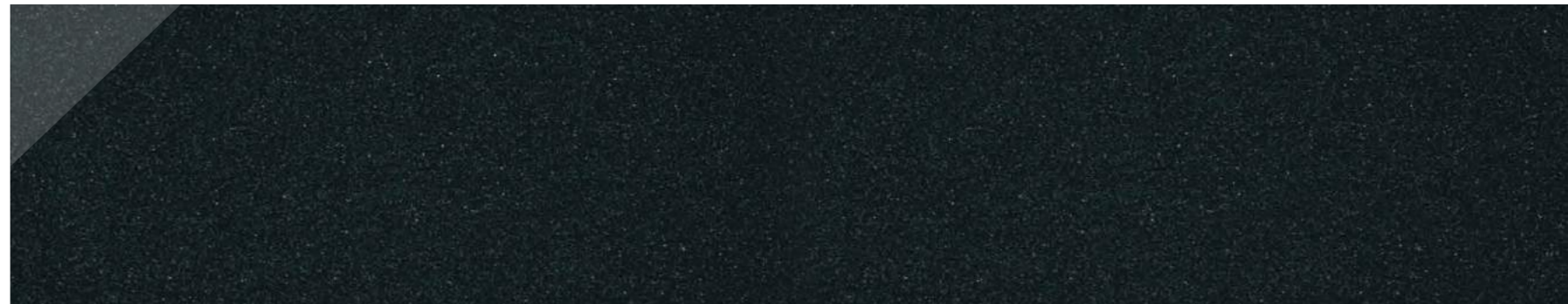

HPL

HPL

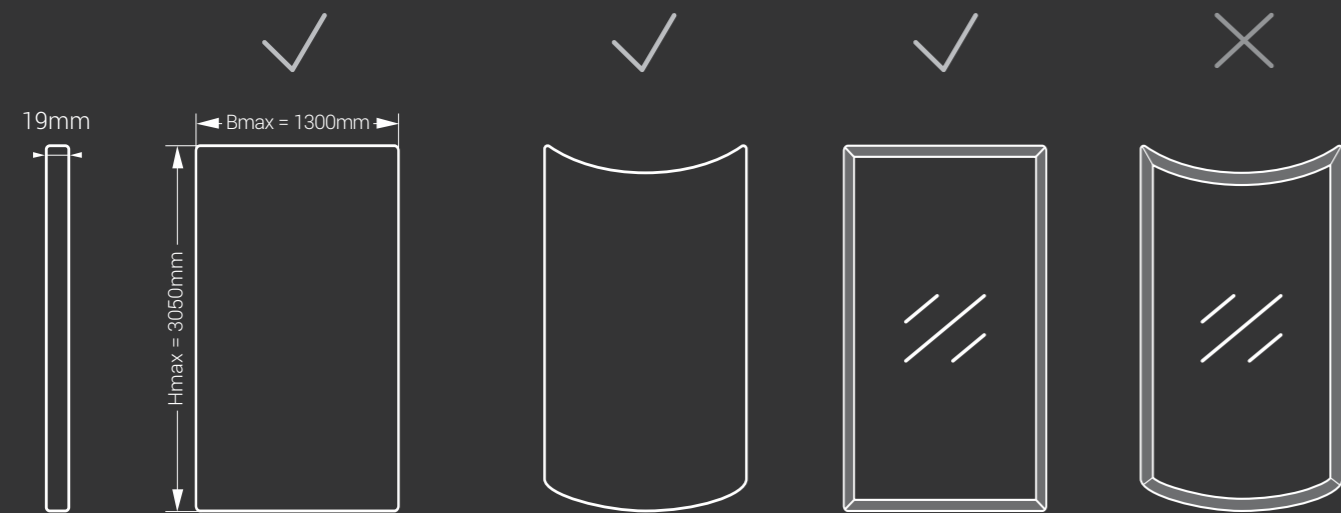

Chipboard base material
Spanplatte als Trägermaterial

EN

ABS edgeband in matching color, ABS Aluminium,
3D edgebands (3D Silver, 3D Bronze, 3D Plywood)

DE

ABS-Kante in passender Farbe, ABS Aluminium,
3D-Kanten (3D Silber, 3D Bronze, 3D Furnier)



Cascina Pine
Cascina Pinie



Arizona Oak Grey
Arizona Eiche Grau



Davos Oak Truffle Brown
Davos Eiche Trüffelbraun



Kansas Oak Brown
Eiche Braun



Thuja



Willow Weide



Texture
Struktur



ABS edgeband in matching color
ABS-Kante in passender Farbe

Matt



Gloss Glanz



Fumed Oak
Wassereiche



Claystone White
Argillit Weiß



Chromix Silver
Chromix Silber



Chromix Anthracite
Chromix Anthrazit



Ceramic Anthracite
Keramik Anthrazit



Ceneri Matt



ABS ABS edgeband in matching color
ABS-Kante in passender Farbe

Matt



Gloss Glanz



Taupe Matt



Volcano Matt



Latteri Matt

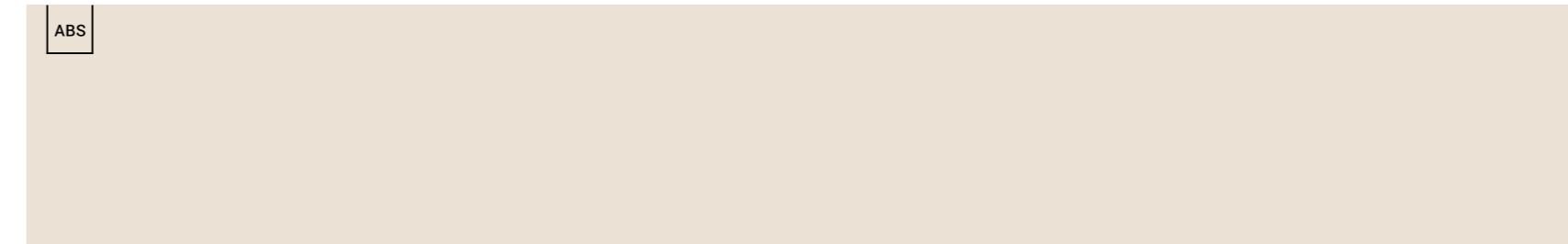

Icy Matt

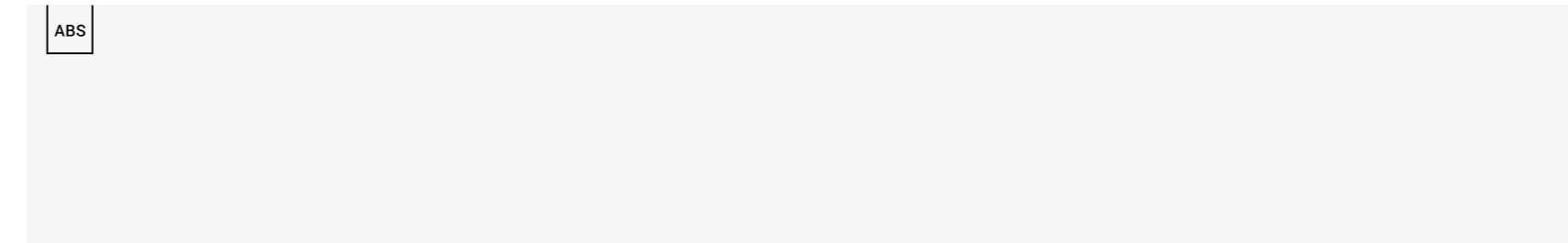

Arctic White
Arktisches Weiß

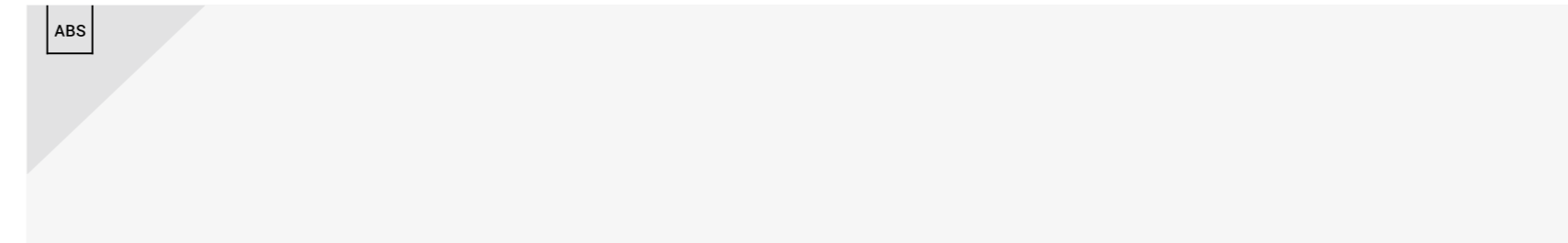

Snow Schnee

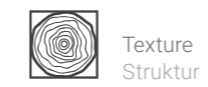
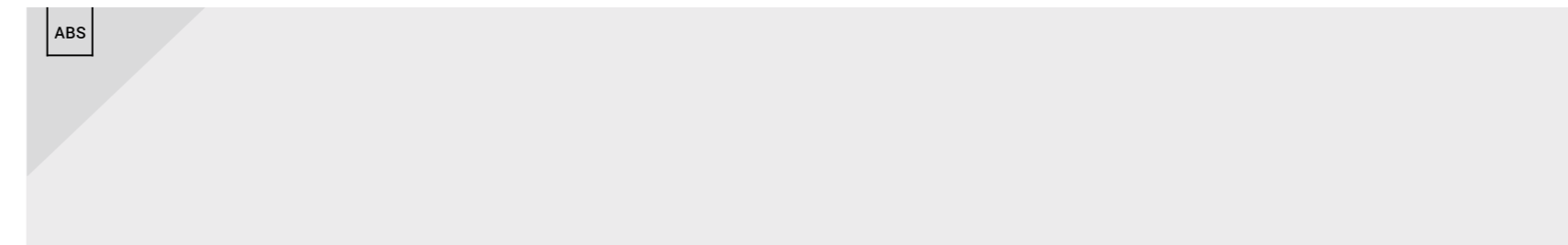

ABS ABS edgeband in matching color
ABS-Kante in passender Farbe

Matt



Gloss Glanz



Silk Seide

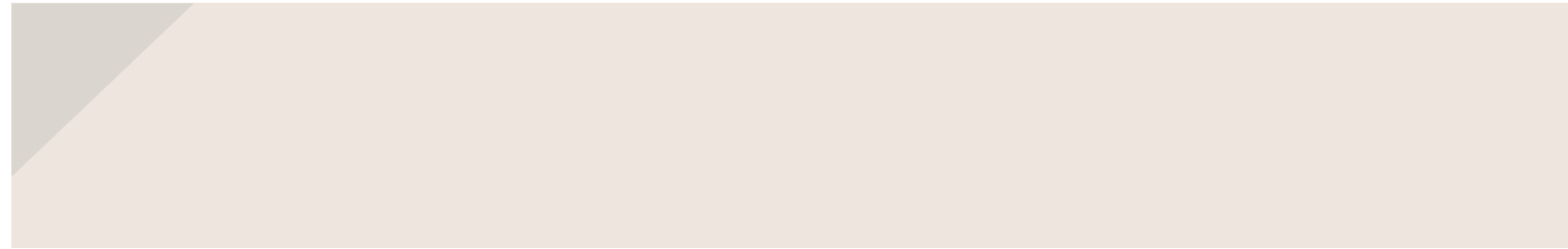

Grey Grau



Nougat

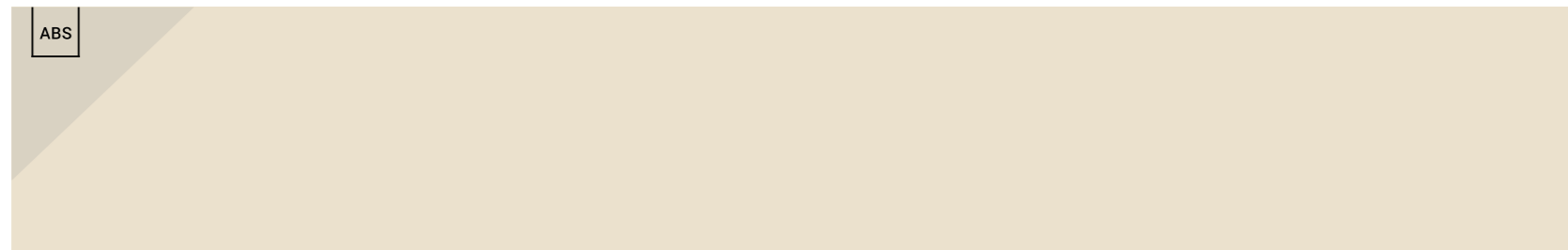

Beige Monochrome
Beige Monochrom



Khaki



Mint Minz



ABS ABS edgeband in matching color
ABS-Kante in passender Farbe

Matt



Gloss Glanz



Light Green Gloss
Salat Glanz



Light Green Matt Salat
Matt



Green Grün



Yellow Gelb



Orange



Cinnamon Zimt



ABS ABS edgeband in matching color
ABS-Kante in passender Farbe

Matt



Gloss Glanz



Storm Sturm



Aubergine



Violet Veilchen



Coffee Kaffee

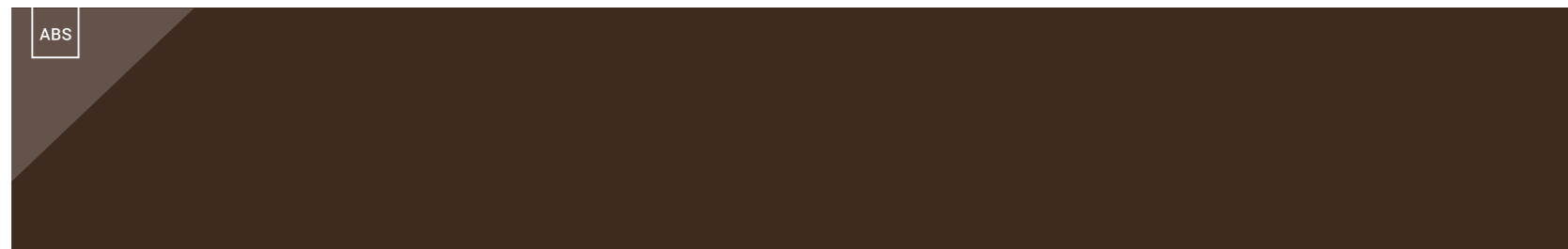

Night Nacht



Red Monochrome
Rot Monochrom



Copper Pearlized
Kupfer Perlmutt



Grey Pearlized
Grau Perlmutt



Turquoise Pearlized
Türkis Perlmutt



Gold Pearlized
Gold Perlmutt

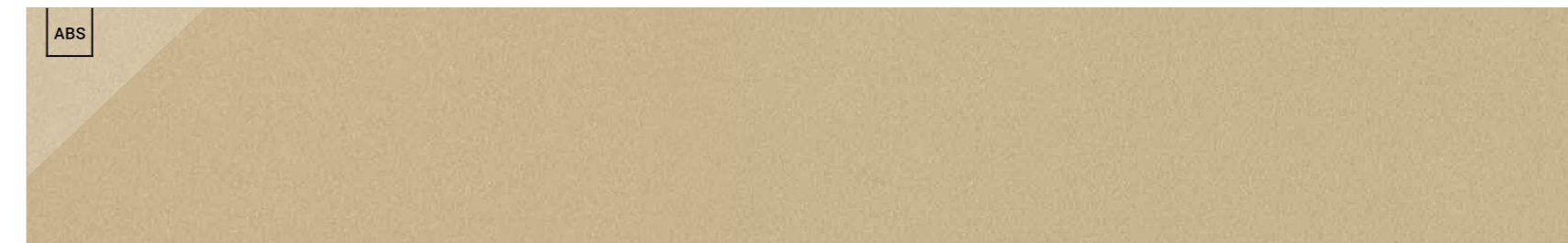

Texture
Struktur

ABS ABS edgeband in matching color
ABS-Kante in passender Farbe

Matt



Gloss Glanz



Texture
Struktur

ABS ABS edgeband in matching color
ABS-Kante in passender Farbe

Matt



Gloss Glanz



PVC

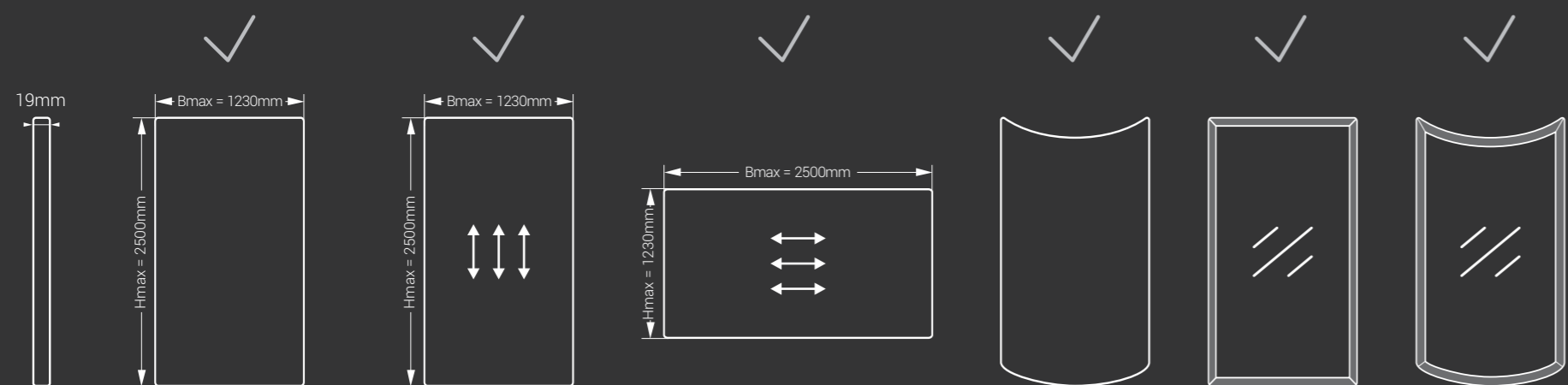

MDF base material
MDF-Trägerplatte



Oak Pure Synchro
Eiche Pur Synchro



Oak Classic Synchro
Eiche Klassik Synchro



Oak Cognac Synchro
Eiche Cognac Synchro



Oak Delight Synchro
Eiche Delight Synchro



Synchronized embossing PVC designs for even more natural look and striking overall impression
PVC-Dekore mit Synchronpore für besonders natürlichen Look und markanten Gesamteindruck



Texture
Struktur

Matt



Gloss Glanz



White Supermatt
Weiß Supermatt



Antique White
Antikes Weiß



Satin Beige

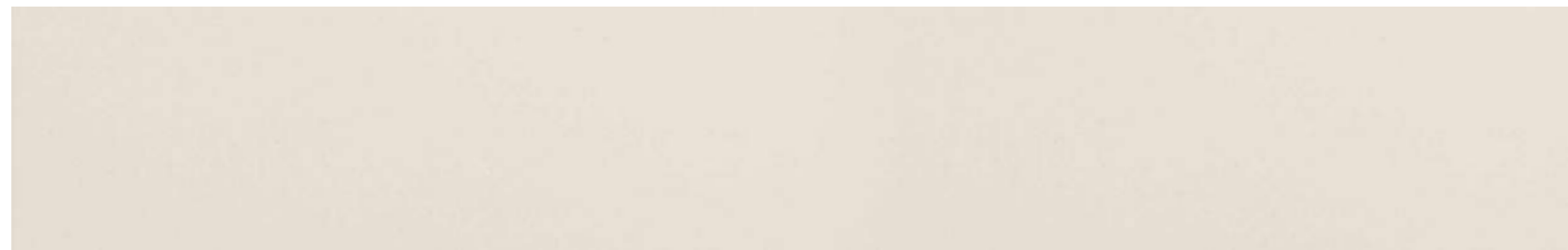

Vanilla Vanille

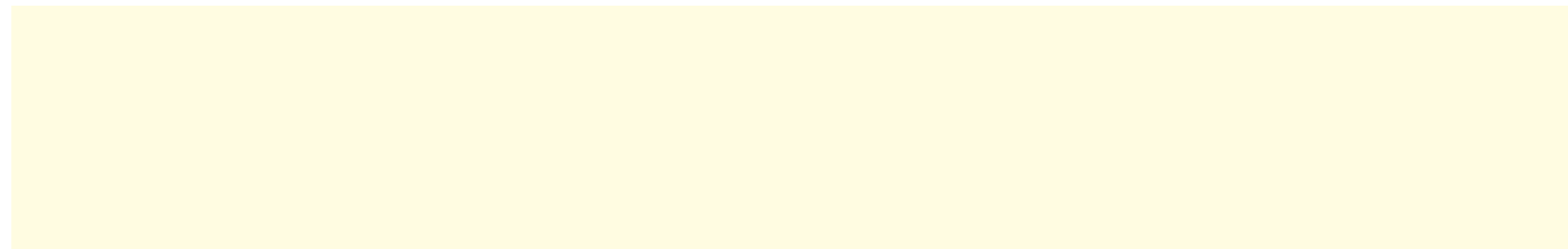

Linen



Latte

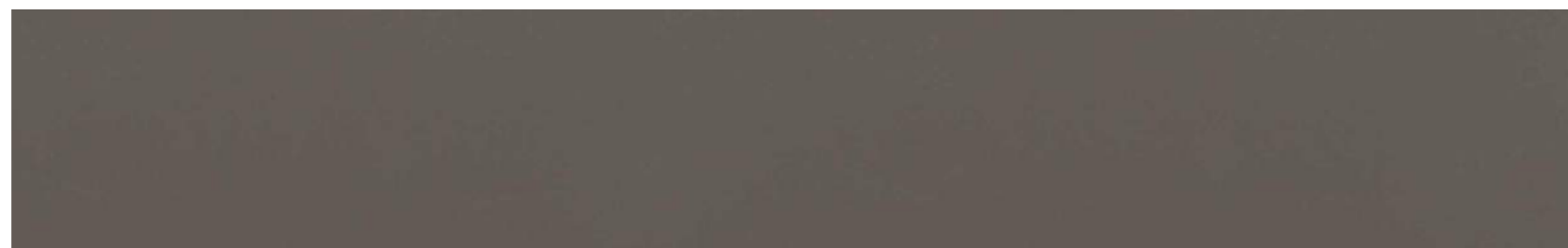

Matt



Gloss Glanz



Wolfram Grey
Wolfram Grau



Pomegranate
Granatapfel



Fern Fam



Fjord

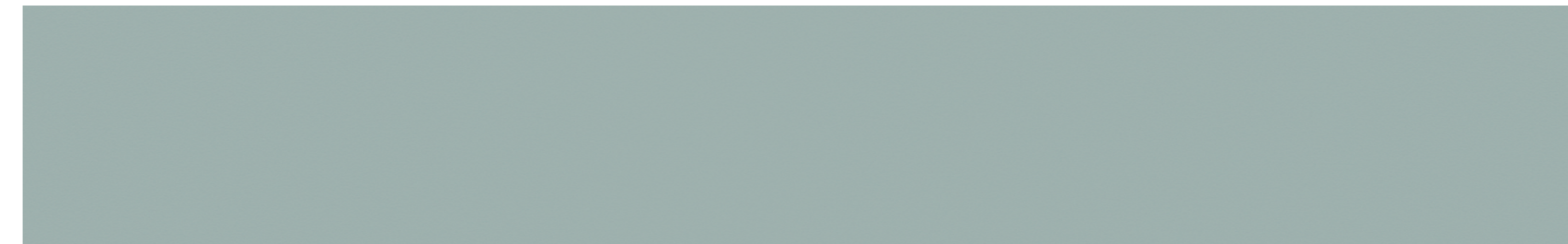

Denim



Marine



Matt



Gloss Glanz



Black Gloss
Schwarz Glanz



Bister Gloss Bister Glanz



Agave Gloss Agave Glanz



Marengo



Onyx Grey
Onyx Grau



Mocaccino Gloss
Mocaccino Glanz



Matt

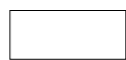

Gloss Glanz



White Gloss Weiß Glanz



Ecru Gloss Ecru Glanz

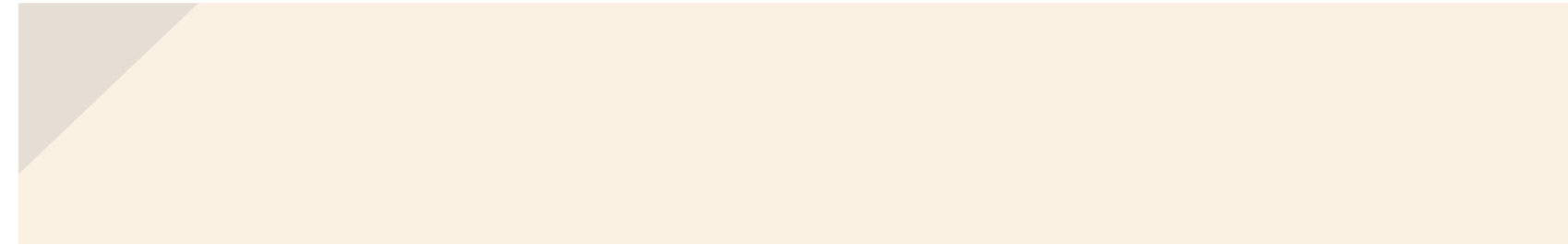

Warm Grey
Warmes Grau

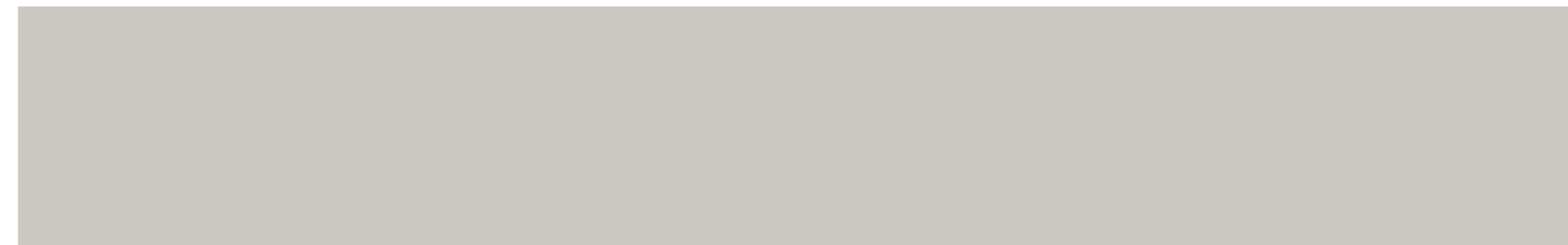

Silver

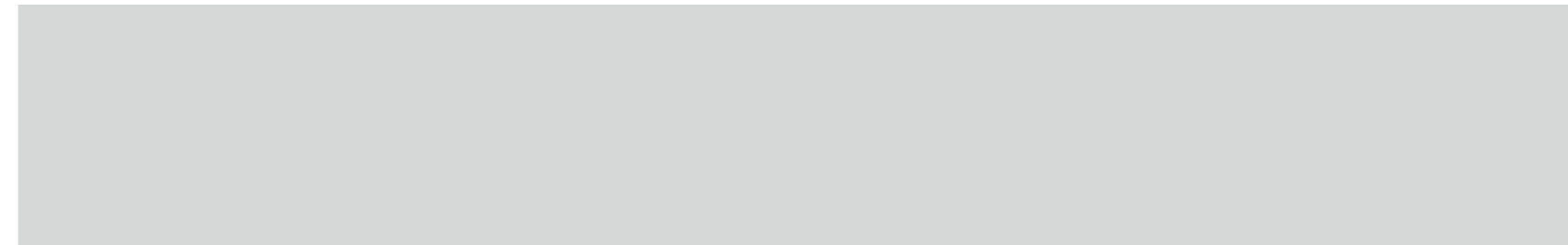

White Tree
Weißbaum

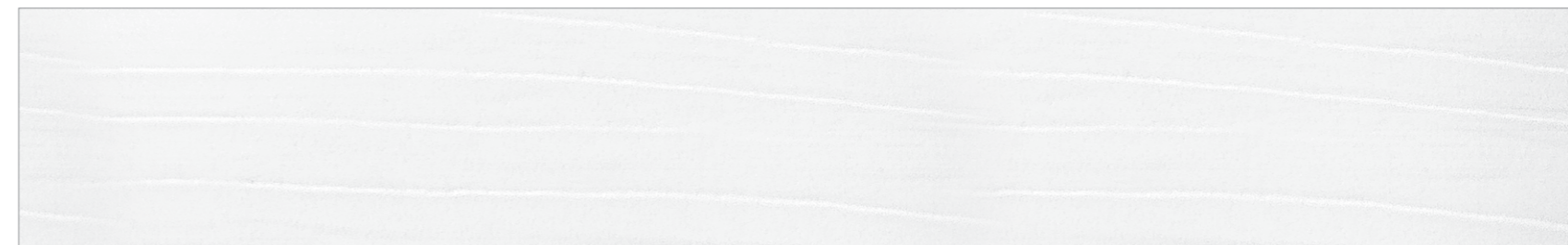

Ash Milky
Milchesche

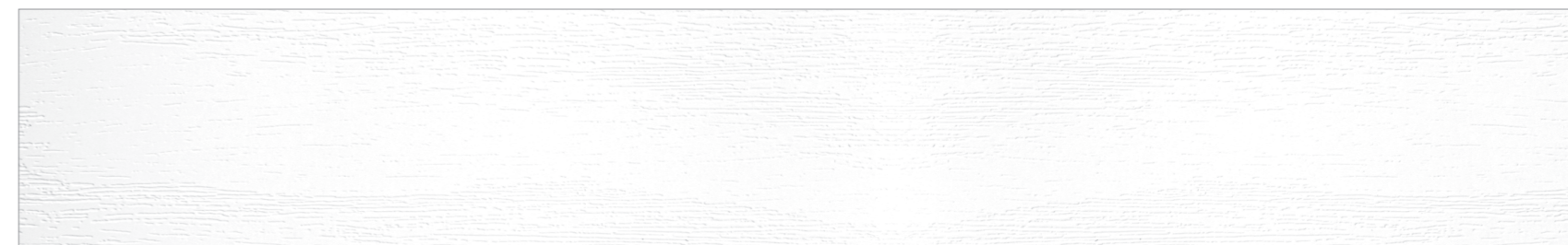

Texture
Struktur

Matt



Gloss Glanz





Ash White Esche Weiß



Ash Light Grey Esche Hellgrau



Ash Light Esche Hell



Hickory



Ash Messina Grey Esche Messina Grau



Ash Melange Esche Melange



Texture Struktur

Matt



Gloss Glanz



Ash Dark Esche Dunkel



Teak Samoa Teakbaum Samoa



Oak Melinda Eiche Melinda

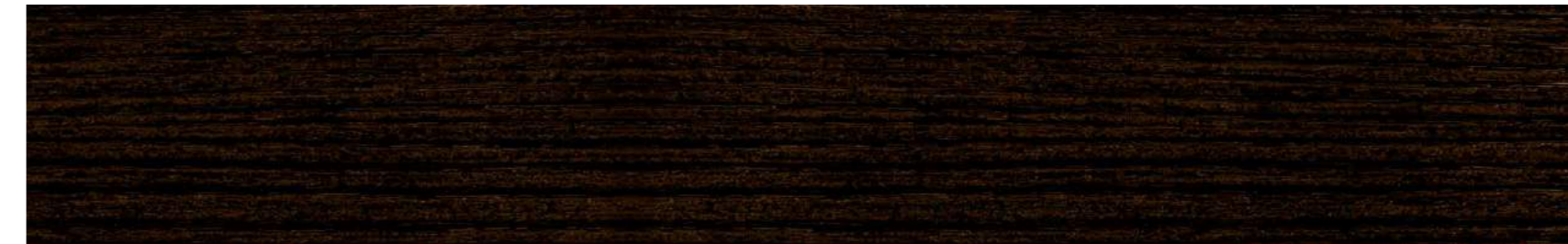

Ash Graphite Esche Graphit



Birch Birke



Sanded Oak Sandeiche



Texture Struktur

Matt



Gloss Glanz





Oak Winchester
Eiche Winchester



Oak Lancelot
Eiche Lancelot



Walnut-015
Nussbaum-015



Copper-brown
Kupferbraun



Olive Gold
Olivengold



Bronze Brown
Bronzebraun



Texture
Struktur

Matt

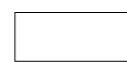

Gloss Glanz



Steely-Grey
Stahlgrau

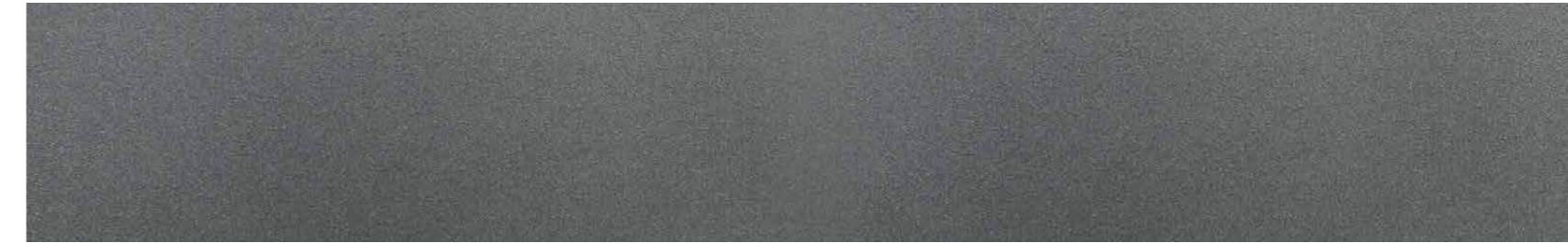

Dark Blue
Dunkelblau



Concrete Chicago
Beton Chicago



Concrete Grey
Beton Grau

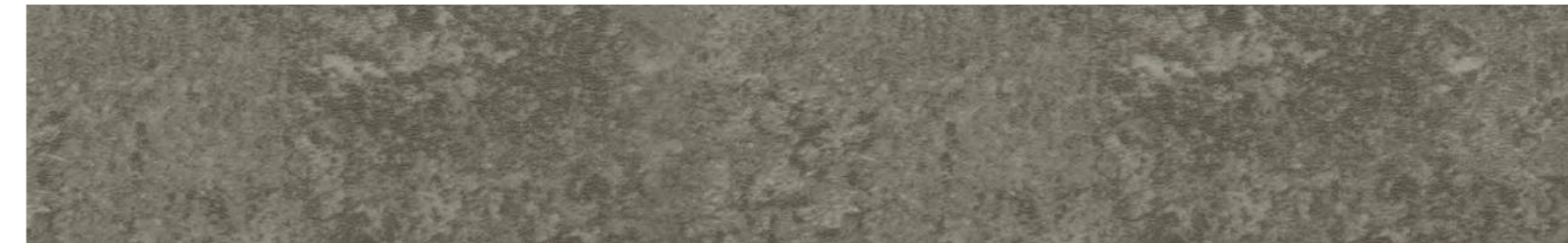

Matt



Gloss Glanz



GLASS GLAS

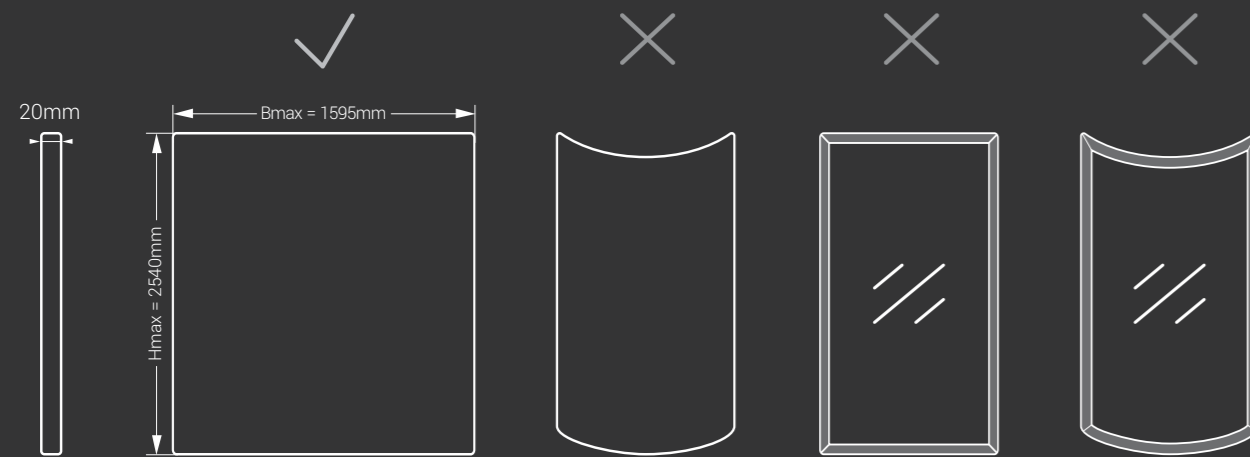

Chipboard base material
Spanplatte als Trägermaterial

EN

Painted glass Lacobel, glass thickness 4mm
 ABS edgeband in matching color (glass with glossy surface), 3D matt edgeband (glass with matt surface)
 Concealed pull grips C-1, C-2 available
 It is not possible to install handles directly on the glass surface
 If height (width) of front exceeds 1000mm, a special support is mounted on the backside of the front

DE

Lackiertes Glas Lacobel, Glasstärke 4mm
 ABS-Kante in passender Farbe (Glas mit Glanzoberfläche), 3D-Kante matt (Glas mit matter Oberfläche)
 Verdeckte Griffleisten C-1, C-2 verfügbar
 Es ist nicht möglich, die Griffe direkt am Glas zu befestigen
 Wenn die Fronten höher (breiter) als 1000mm sind, wird eine Stütze auf der Rückseite der Front montiert

Ocean Matt

RAL 7000

Pronx Matt

Smoky Matt

RAL 7016

Snow Matt

RAL 9003

Itra White
Ultraweiß

RAL 9003

Matt



Gloss Glanz



Pearl Perle

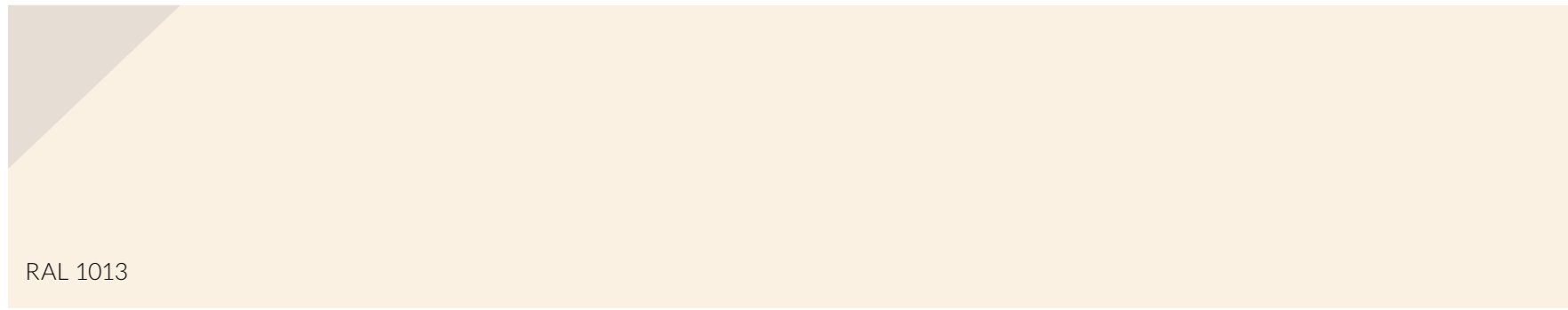

RAL 1013

Almond Mandel



RAL 1236

Umbr

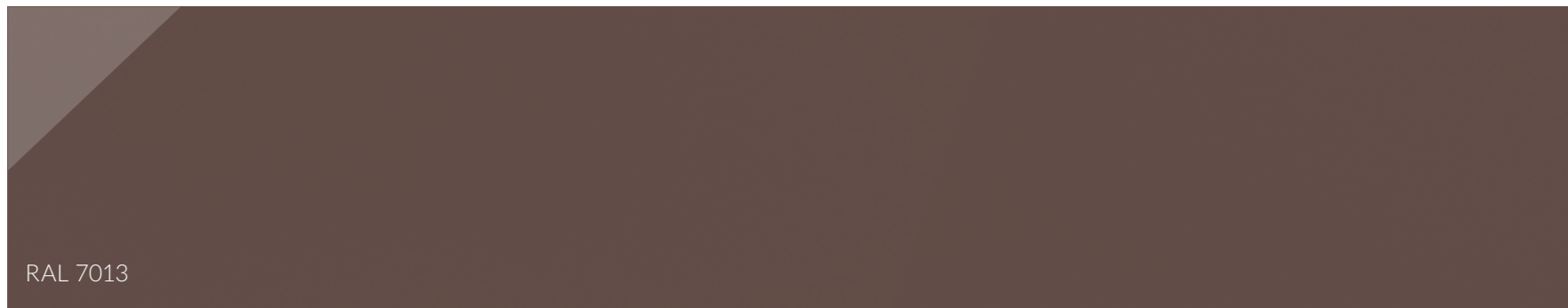

RAL 7013

Resin Harz

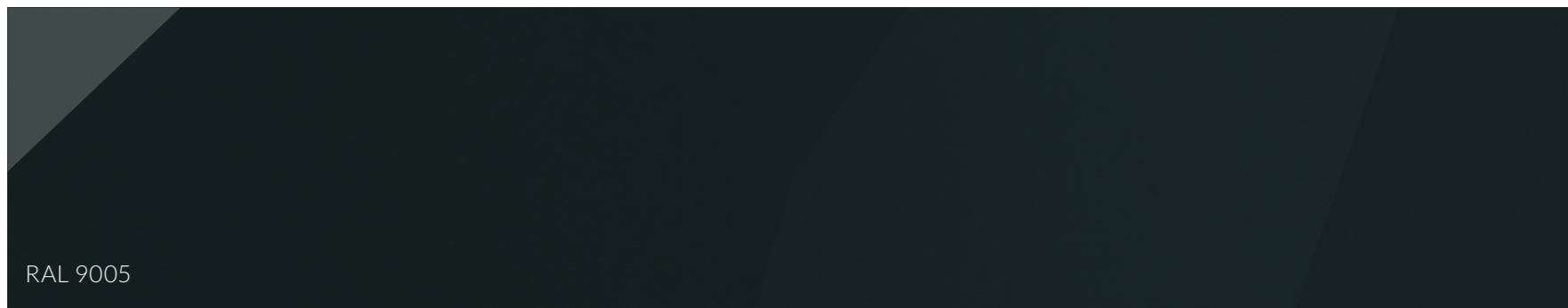

RAL 9005

Ocean Gloss
Ocean Glanz

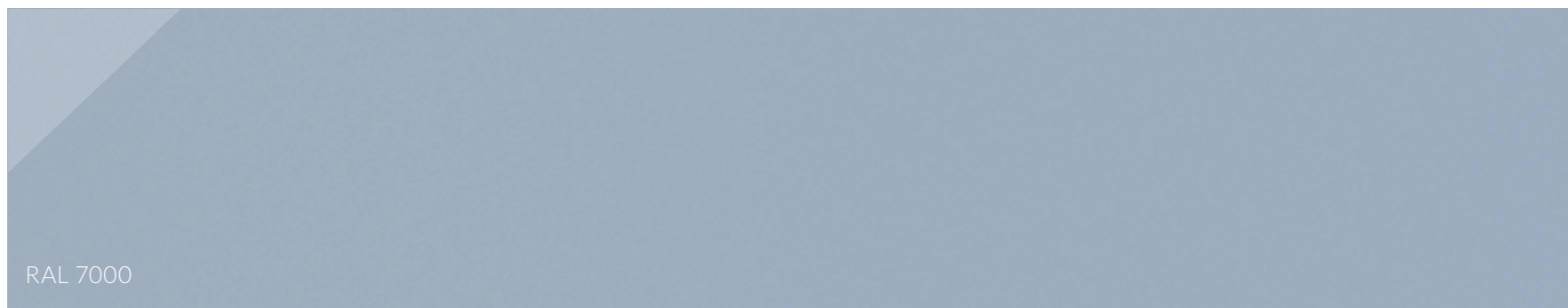

RAL 7000



Smoky Gloss
Smoky Glanz



RAL 7016

Asparagus



RAL 8715

Flamingo



RAL 0627



LACQUERED MDF IN CONCRETE LOOK

LACKIERTE MDF-PLATTE IN BETONOPTIK

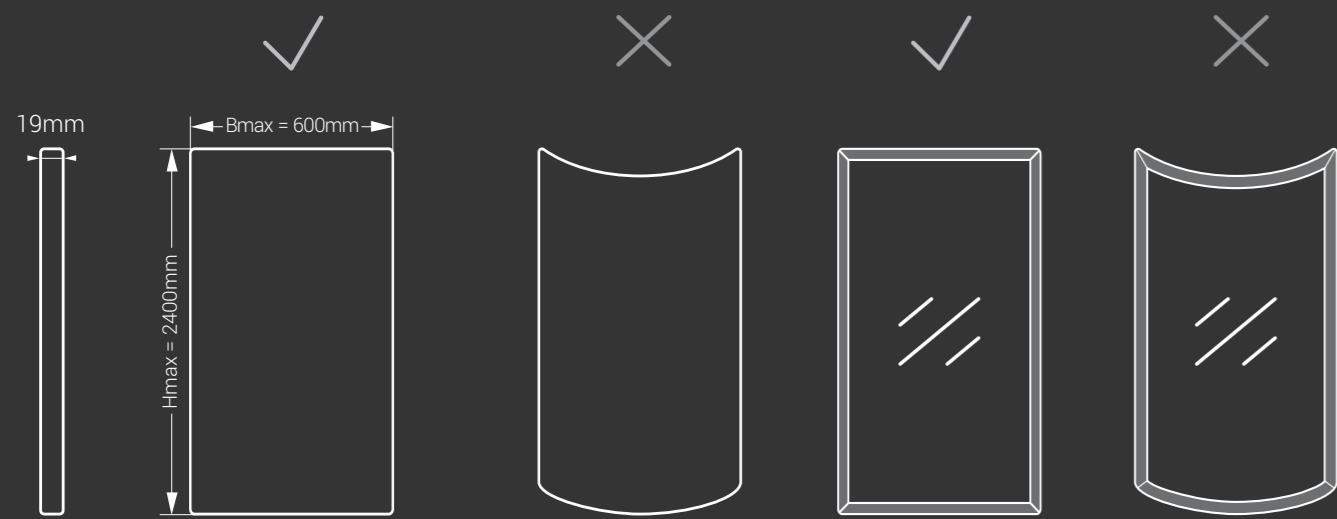

EN

Double-sided lacquering is available on request (in that case the backside of front will have matt monochrome finish).

DE

Beidseitiges Lackieren ist auf Wunsch möglich (in diesem Fall wird die Rückseite der Front matt und monochrom).

Beige

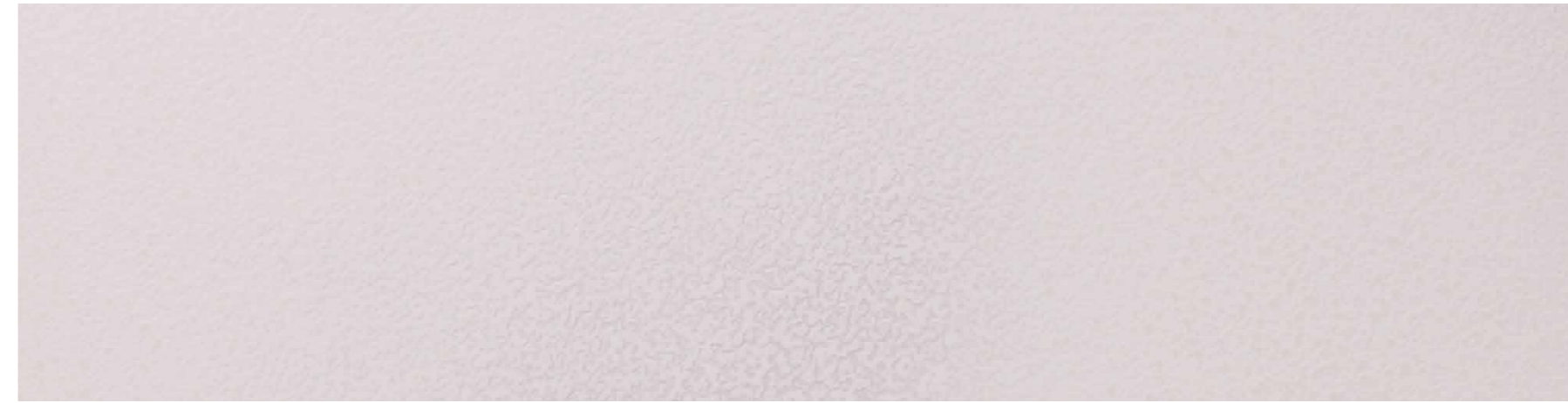

White
Weiß



Grey
Grau



Black
Schwarz

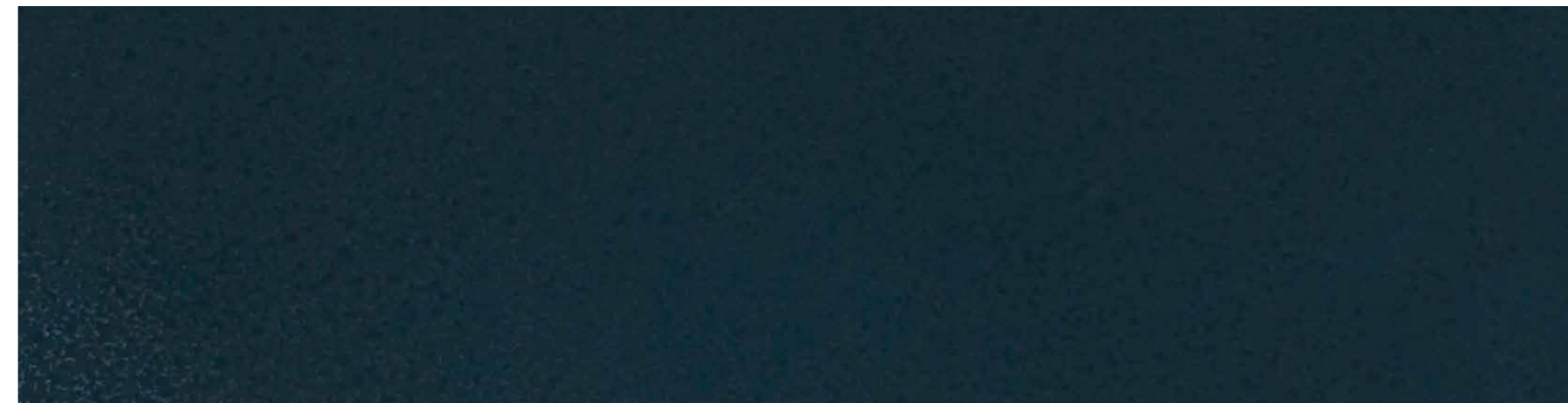

DECORATIVE EDGE BANDS DEKORKANTEN

For HPL, acrylic fronts Für HPL, Acrylfronten

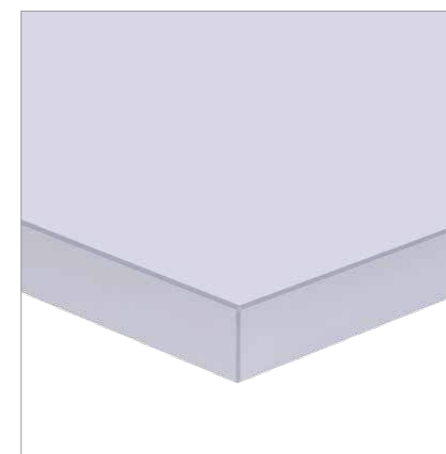

ABS Aluminum ABS Aluminium



3D Silver 3D Silber

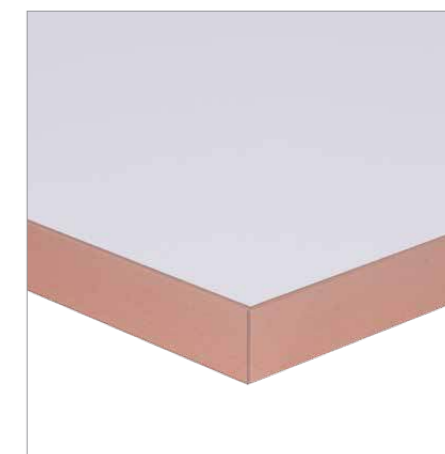

3D Bronze 3D Bronze



3D Plywood 3D Furnier

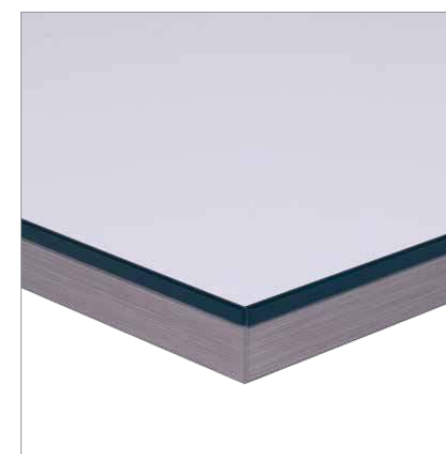

3D-Duo Black 3D-Duo
Schwarz



3D-Duo White 3D-Duo Weiß

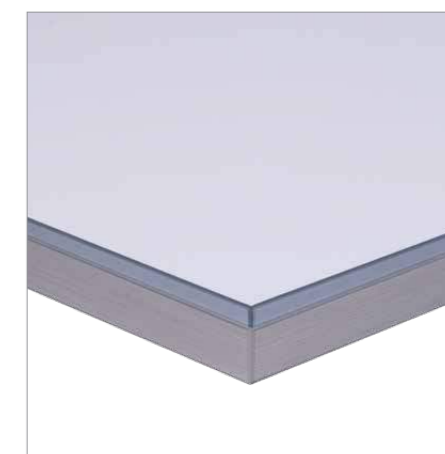

3D-Duo Grey 3D-Duo Grau

For fronts of matt glass (recommended combinations) Für Fronten aus Mattglas (empfohlene Kombinationen)

Glass Snow Matt
Glas Snow Matt



3D White Matt 3D Weiß Matt

Glass Smoky Matt
Glas Smoky Matt

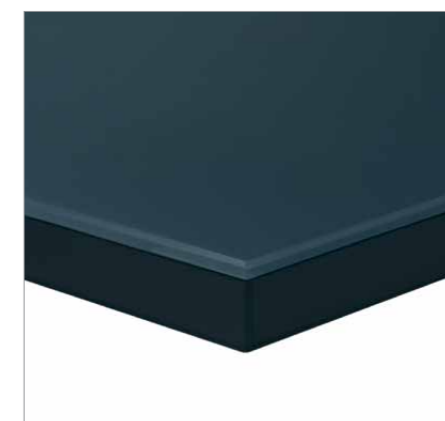

3D Black Matt 3D Schwarz Matt

Glass Pronx Matt
Glas Pronx Matt



3D Gold Matt

Glass Ocean Matt
Glas Ocean Matt



3D Silver Matt 3D Silber Matt

PRINTED GLASS BEDRUCKTES GLAS

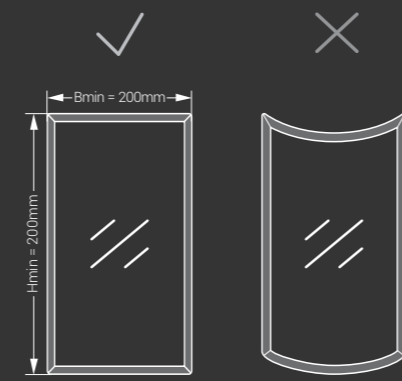

Available glass options Verfügbares Glas



Satin Matt 4mm



Satin Graphite 4mm
Satin Graphit 4mm

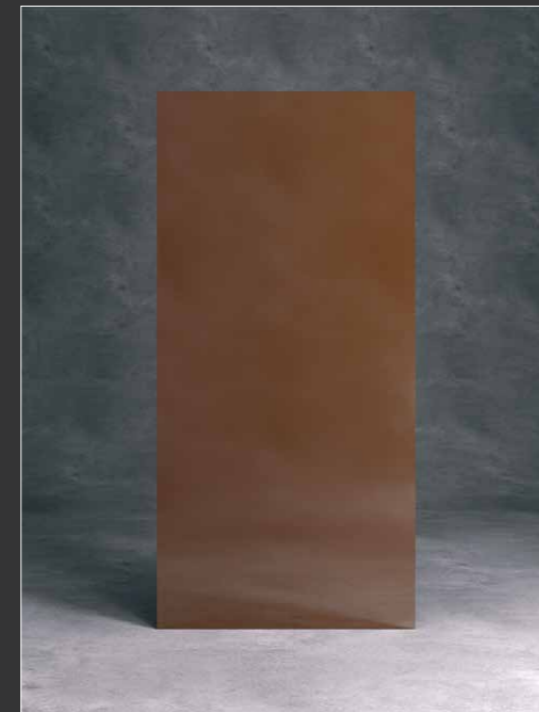

Satin Bronze 4mm

EN

Vertical and horizontal pattern orientation
The front side in glossy finish, the backside with printed pattern in matt finish

DE

Vertikale und horizontale Musterausrichtung
Die Vorderseite in glänzender Ausführung, die bedruckte Rückseite in matter Ausführung

Pattern options Mustervarianten



Glass 01



Glass 02



Glass 03



Glass 04



Glass 05



Glass 06



Glass 07



Glass 08



Glass 09



Glass 10



Glass 11



Glass 12



Glass 13



Glass 14



Glass 15



Glass 16



Glass 25*



Glass 26*



Glass 17*



Glass 18*



Glass 19*



Glass 20*



Glass 21*



Glass 22*



Glass 23*



Glass 24*

* The pattern with fixed size
* Das Muster mit Fixgröße

ETCHED GLASS GEÄTZTES GLAS

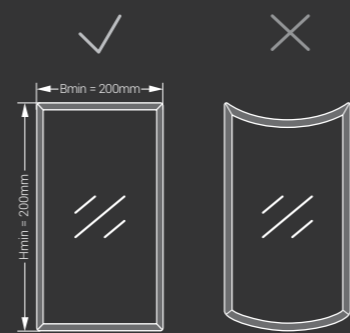

Available glass options Verfügbares Glas



Clear glass 4mm
Klarglas 4mm



Clear glass Graphite 4mm
Klarglas Graphit 4mm



Lacomat 4mm



Clear glass Bronze 4mm
Klarglas Bronze 4mm



Satin Bronze 4mm



Satin Graphite 4mm
Satin Graphit 4mm



Satin Matt 4mm

EN

Vertical and horizontal pattern orientation
The front side in glossy finish, the backside with printed pattern in matt finish

DE

Vertikale und horizontale Musterausrichtung
Die Vorderseite in glänzender Ausführung, die bedruckte Rückseite in matter Ausführung

Pattern options Mustervarianten



V10



V13



V14

SANDBLASTED GLASS SANDGESTRAHLTES GLAS



Available glass options Verfügbares Glas



Clear glass 4mm (by default)
Klarglas 4mm (standardmäßig)



Clear glass Bronze 4mm
Klarglas Bronze 4mm



Clear glass Graphite 4mm
Klarglas Graphit 4mm



Clear glass Obsidian 4mm
Klarglas Obsidian 4mm

EN

All sandblasted glasses are varnished
Any pattern from customer's drawing can also be applied on glass
All available patterns can be with 3D effect

DE

Sandgestrahltes Glas wird immer lackiert
Jedes vom Kunden gewünschte Muster kann auf die Glasfüllung aufgebracht werden
Alle verfügbaren Muster sind in 3D-Optik möglich

Pattern options Mustervarianten



#36



#36 3D effect 3D-Optik



#38



#53



#59



#62



#69



#70

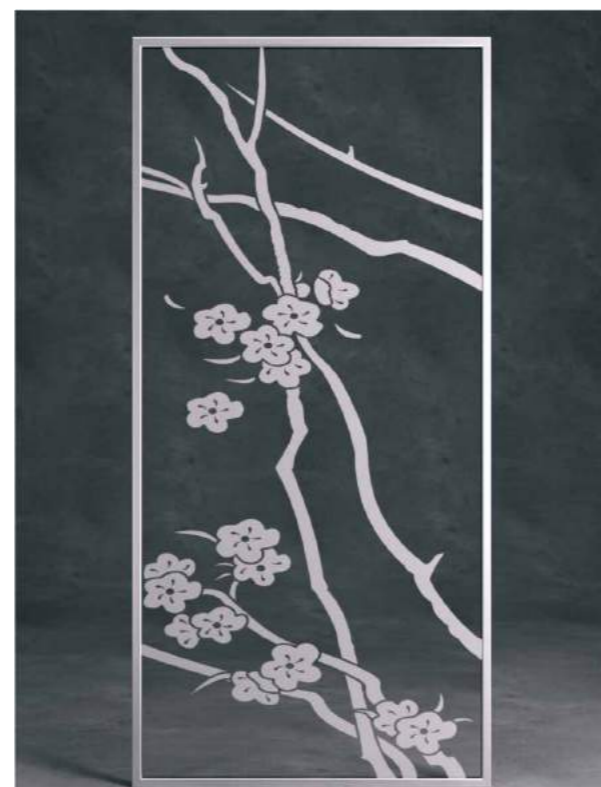

#71



#83

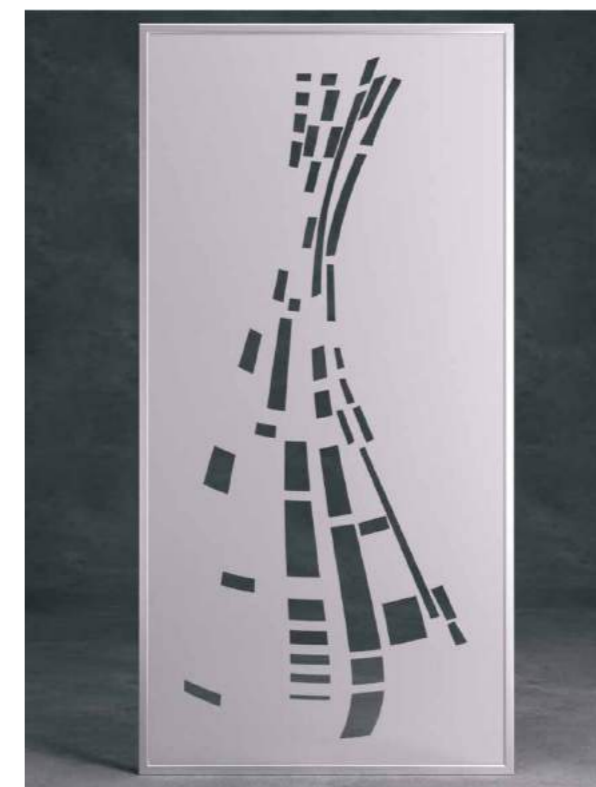

#86



#87



#77 эффект 3D 3D effect 3D-Optik



#81



#82



#76 3D effect 3D-Optik

GLASS WITH LEAD STRIPS GLAS MIT BLEISTREIFEN



Available glass options Verfügbares Glas



Clear glass 4mm (by default)
Klarglas 4mm (standardmäßig)



Clear glass Bronze 4mm
Klarglas Bronze 4mm



Clear glass Graphite 4mm
Klarglas Graphit 4mm



Clear glass Obsidian 4mm
Klarglas Obsidian 4mm

EN

Self-adhesive lead strips are available in two colors: Gold, Chrome
Colored elements are coated with a stained film

DE

Selbstklebende Bleistreifen sind in zwei Farben verfügbar: Gold, Chrom.
Farbige Elemente werden mit einer bunten Kunstfolie überzogen

Pattern options Mustervarianten



#4



#8



#11



#12



#13



#20



#24



#26



#27



ST-9



ST-10



ST-12



#30



ST-7



ST-8



ST-13

RESIN STAINED GLASS HARZ-BUNTGLAS



Available glass options Verfügbares Glas



Clear glass 4mm (by default)
Klarglas 4mm (standardmäßig)



Clear glass Bronze 4mm
Klarglas Bronze 4mm



Clear glass Graphite 4mm
Klarglas Graphit 4mm



Clear glass Obsidian 4mm
Klarglas Obsidian 4mm

EN

A specially formulated two-component resin is used to imitate lead comes and create a vibrant and colorful pattern.

Available resin colors: Gold, Chrome, Transparent, Black.

DE

Das speziell entwickelte Zweikomponentenharz ist für das Imitieren von Bleistreifen angewendet, um eine lebendige, bunte Glasdekoration zu schaffen. Farbige Elemente werden auch mit Harz gefüllt.

Imitierte Bleistreifen sind in folgenden Ausführungen möglich: Gold, Chrom, Transparent, Schwarz.

Pattern options Mustervarianten



CR-01



CR-02



CR-03



CR-04



CR-05



CR-06



CR-10



CR-11



CR-12



CR-13



CR-14



CR-15

SILK-SCREEN PRINTED GLASS SIEBBDRUCKTES GLAS



Available glass options Verfügbares Glas



Clear glass Bronze 4mm (by default) Klarglas
Bronze 4mm (standardmäßig)



Clear glass 4mm Klarglas 4mm



Clear glass Graphite 4mm Klarglas
Graphit 4mm



Clear glass Obsidian 4mm Klarglas
Obsidian 4mm

EN

Patterns are available in two colors: Gold (by default), Chrome

DE

Die Muster sind in zwei Farben verfügbar: Gold (standardmäßig), Chrom

Pattern options Mustervarianten



Cells #1 Zellen #1
Max. height/width 1200/500mm
Max. Höhe/Breite 1200/500mm



Cells #2 Zellen #2
Min./max. height 150/980mm
Min./max. width 200/480mm
Min./max. Höhe 150/980mm
Min./max. Breite 200/480mm



Cells #3 Zellen #3
Min./max. height 400/890mm
Min./max. width 250/480mm
Min./max. Höhe 400/890mm
Min./max. Breite 250/480mm



Cells #4 Zellen #4
Max. width 590mm
Max. Breite 590mm

BEVELED GLASS

GLAS MIT FACETTENTEILEN (BEVELS)



Available glass options Verfügbares Glas



Sandblasted 4mm
(by default)
Sandgestrahlt 4mm
(standardmäßig)

Clear glass 4mm
Klarglas 4mm

Clear glass Bronze 4mm
Klarglas Bronze 4mm

Clear glass Graphite 4mm
Klarglas Graphit 4mm

Clear glass Obsidian 4mm
Klarglas Obsidian 4mm

EN

Self-adhesive lead strips are available in two colors:
Gold, Chrome

DE

Selbstklebende Bleistreifen sind in zwei Farben
verfügbar: Gold, Chrom

Pattern options Mustervarianten



B1
Min. height/width 400/250mm
Min. Höhe/Breite 400/250



B2
Min. height/width 310/250mm
Min. Höhe/Breite 310/250mm



B3
Min. height/width 200/130mm
Min. Höhe/Breite 200/130mm



B4
Min. height/width 300/160mm
Min. Höhe/Breite 300/160mm



B5
Min. height/width 200/130mm
Min. Höhe/Breite 200/130mm



B6
Min. height/width 250/160mm
Min. Höhe/Breite 250/160mm



B7
Min. height/width 600/160mm
Min. Höhe/Breite 600/160mm



B8
Min. height/width 600/320mm
Min. Höhe/Breite 600/320mm

GLASS WITH FUSED TILES GLAS MIT VERSCHMOLZENEN GLASFLIESEN



Available glass options · Verfügbares Glas

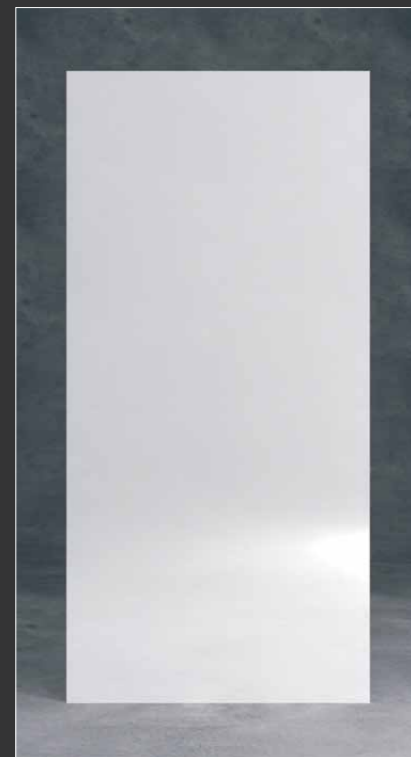

Sandblasted 4mm (by default)
Sandgestrahlt 4mm (standardmäßig)



Satin Bronze 4mm
Satin Bronze 4mm



Satin Graphite 4mm
Satin Graphit 4mm



Satin Obsidian 4mm
Satin Obsidian 4mm

EN

The size of fused tiles 50x50mm

DE

Die Größe fusionierter Fliesen 50x50mm

Pattern options · Mustervarianten



F-004



F-121



F-310

ALUMINUM FRAME PROFILES FOR GLASS FRONTS

ALUMINIUM-RAHMENPROFILE FÜR GLASFRONTEN

EN

It is not recommended to install handles directly on glass surface. Handles are installed into aluminum frame profile

Glass with self-adhesive lead strips, resin stained and beveled glass, glass with fused tiles and silk-screen printed glass are available for the A-1 and A-2 profiles

DE

Es ist nicht empfohlen, Griffe direkt am Glas zu befestigen. Griffe werden ins Aluminium-Rahmenprofil montiert

Glas mit selbstklebenden Bleistreifen, Harz-Buntglas, Glas mit Facettenteilen und verschmolzenen Glasfliesen, siebbedrucktes Glas sind in die Profile A-1 und A-2 auch einsetzbar



A-1

Aluminum
Aluminium

Profile width 25mm
Profilbreite 25mm



A-1

Terra Black
Terra Schwarz

Profile width 25mm
Profilbreite 25mm



A-1

Cognac
Cognac

Profile width 25mm
Profilbreite 25mm



Handle profile C-5 (for the profile A-1), color Black Matt Griffprofil C-5 (für das Profil A-1), Farbe Schwarz Matt



A-2
Aluminum
Aluminium
Profile width 50mm
Profilbreite 50mm



A-2
Terra Black
Terra Schwarz
Profile width 50mm
Profilbreite 50mm



A-2
Cognac
Cognac
Profile width 50mm
Profilbreite 50mm



A-2
Champagne Brush
Champagne Brush
Profile width 50mm
Profilbreite 50mm



A-3
Aluminum
Aluminium
Profile width 45mm
Profilbreite 45mm

Available glass options Verfügbares Glas



Clear glass 4mm (for the profiles A-1, A-2)
Klarglas 4mm (für die Profile A-1, A-2)



Clear glass Bronze 4mm (for the profiles A-1, A-2)
Klarglas Bronze 4mm (für die Profile A-1, A-2)



Clear glass Graphite 4mm (for the profiles A-1, A-2)
Klarglas Graphit 4mm (für die Profile A-1, A-2)



Clear glass Obsidian 4mm
(for the profiles A-1, A-2)
Klarglas Obsidian 4mm
(für die Profile A-1, A-2)

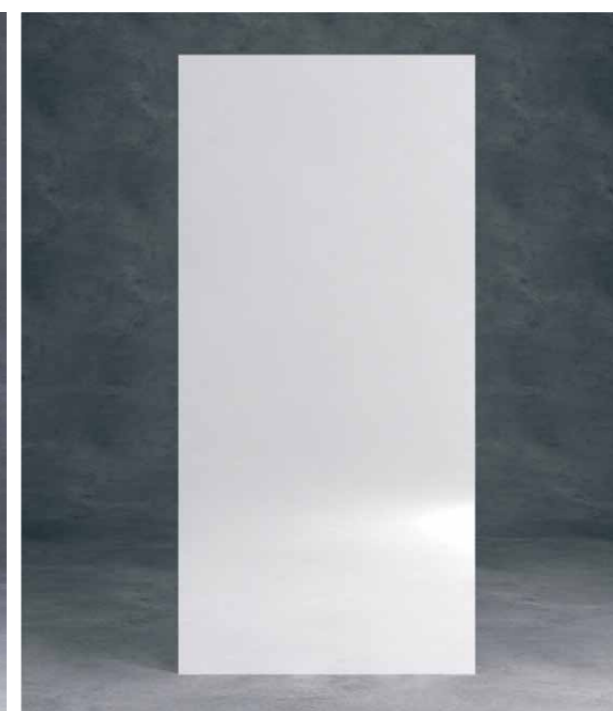

Sandblasted 4mm (for the profiles A-1, A-2)
Sandgestrahlt 4mm (für die Profile A-1, A-2)



Painted (RAL) 4mm non-transparent, beveled
(for the profiles A-1, A-2, A-3)
Lackiert (RAL) 4mm nichttransparent, fazettiert (für die Profile A-1, A-2, A-3)

GLASS FRONTS IN LOFT STYLE GLASFRONTEN IM LOFT-STIL

Available aluminum frame profiles
Verfügbare Aluminium-Rahmenprofile

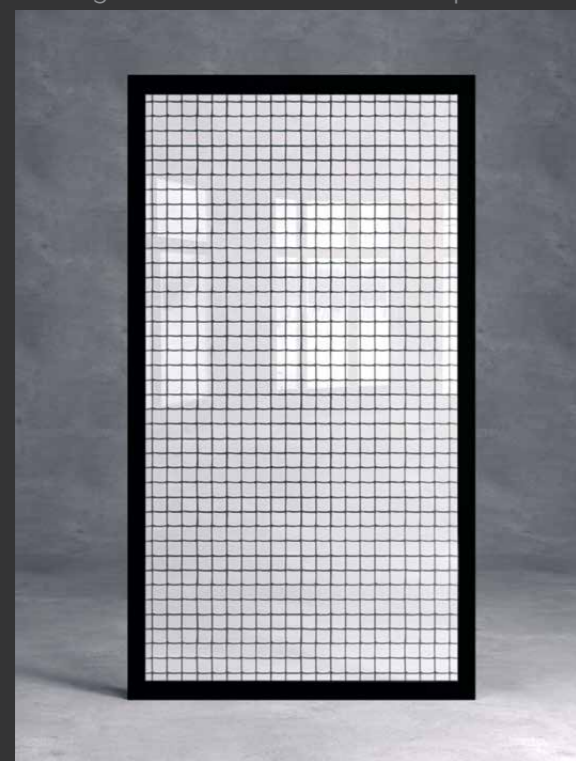

A-1

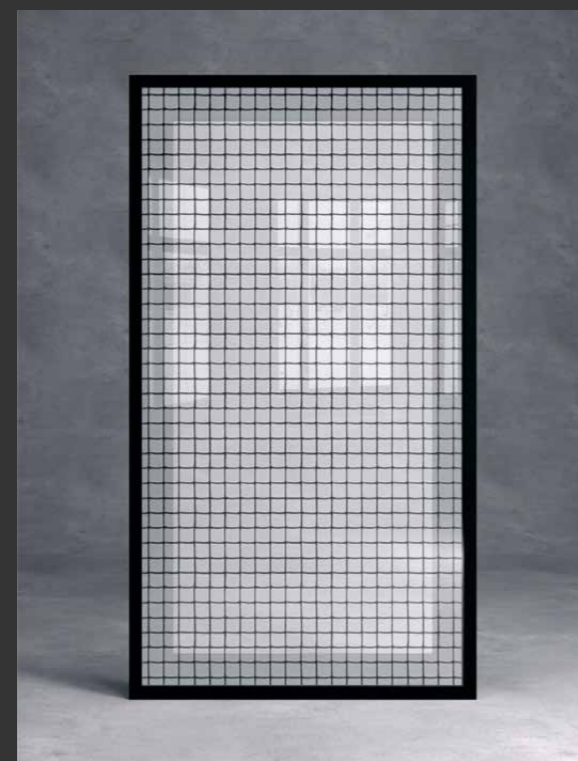

A-2

Loft-1

Available glass options Verfügbares Glas

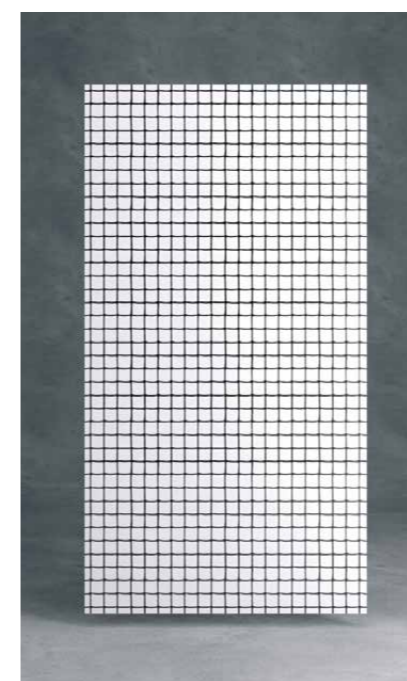

Matt (polymer pattern Chrome)
Matt (Polymermuster Chrom)

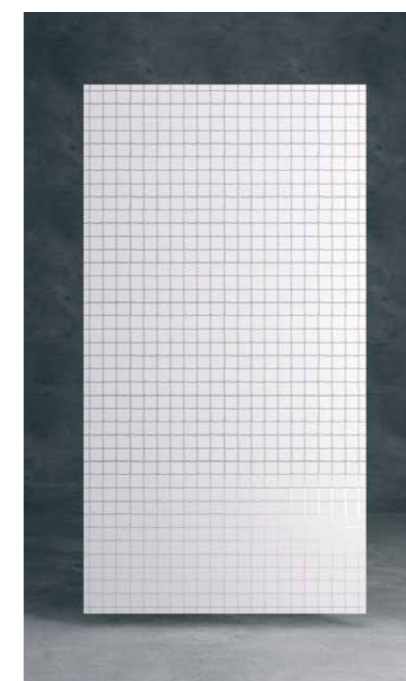

Matt (polymer pattern Transparent)
Matt (Polymermuster Transparent)

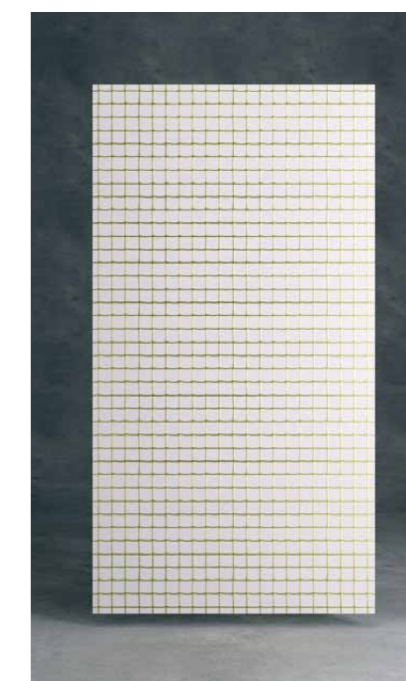

Matt (polymer pattern Gold)
Matt (Polymermuster Gold)

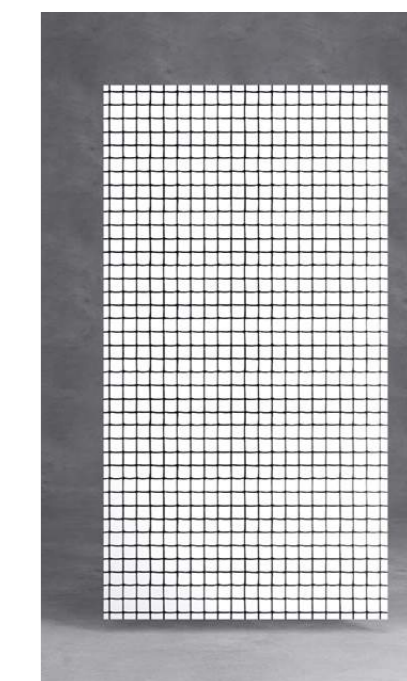

Matt (polymer pattern Black)
Matt (Polymermuster Schwarz)

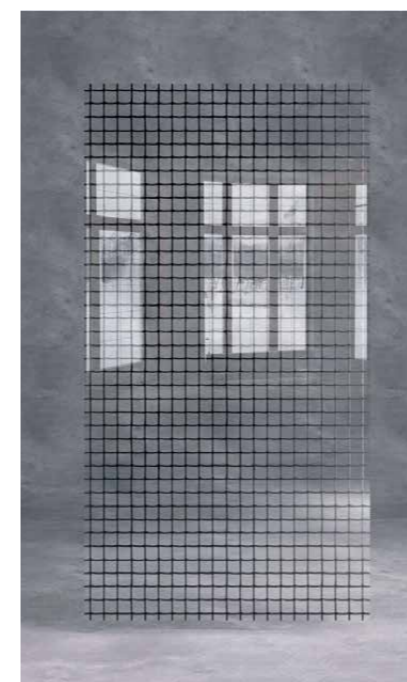

Clear (polymer pattern Chrome)
Klar (Polymermuster Chrom)



Clear (polymer pattern Transparent)
Klar (Polymermuster Transparent)

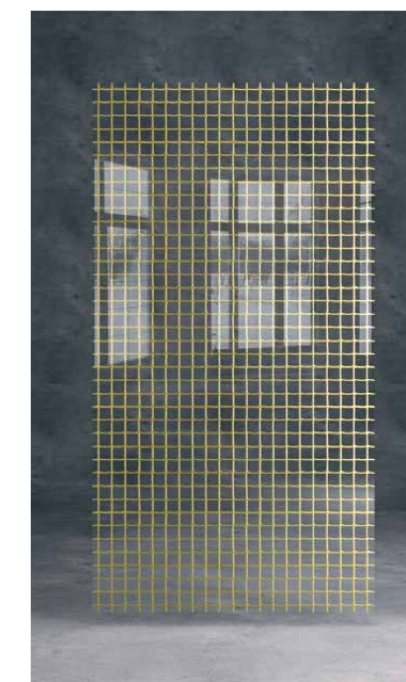

Clear (polymer pattern Gold)
Klar (Polymermuster Gold)

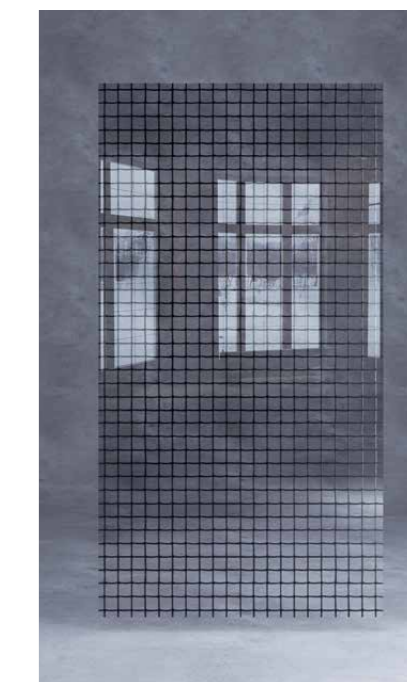

Clear (polymer pattern Black)
Klar (Polymermuster Schwarz)

Square size 13x13mm
Quadratgröße 13x13mm

Loft-2

Available glass options Verfügbares Glas

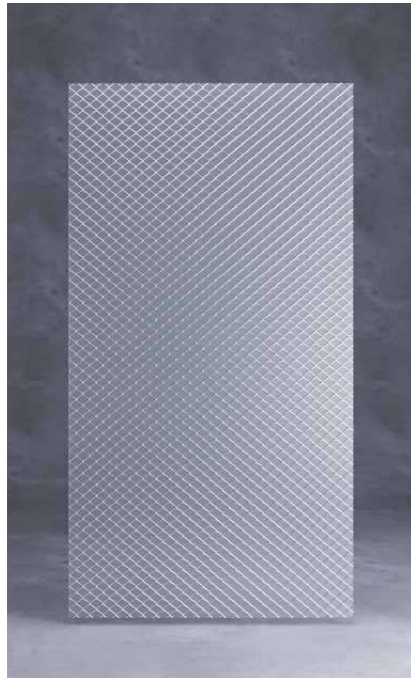

Matt (polymer pattern Chrome)
Matt (Polymermuster Chrom)

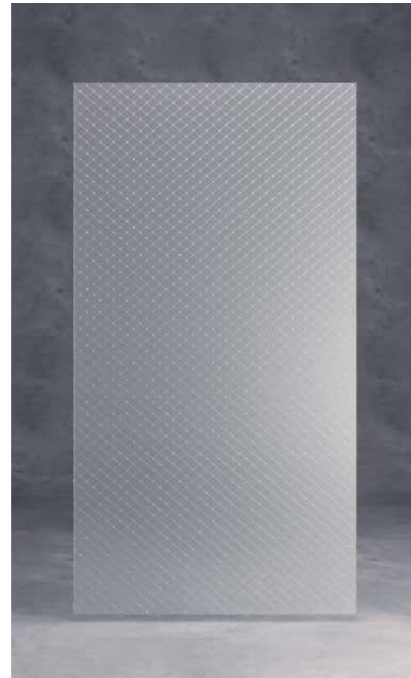

Matt (polymer pattern Transparent)
Matt (Polymermuster Transparent)

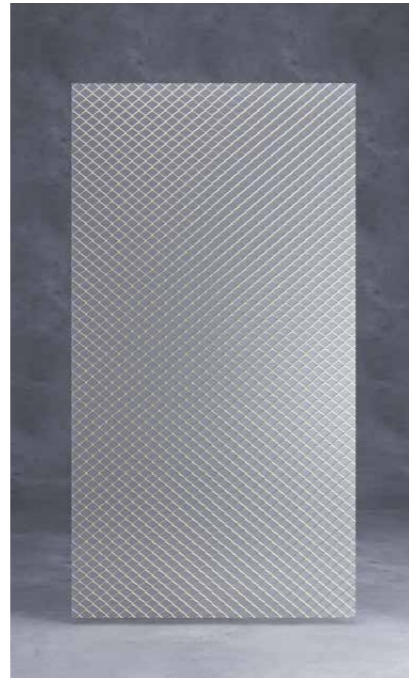

Matt (polymer pattern Gold)
Matt (Polymermuster Gold)



Matt (polymer pattern Black)
Matt (Polymermuster Schwarz)

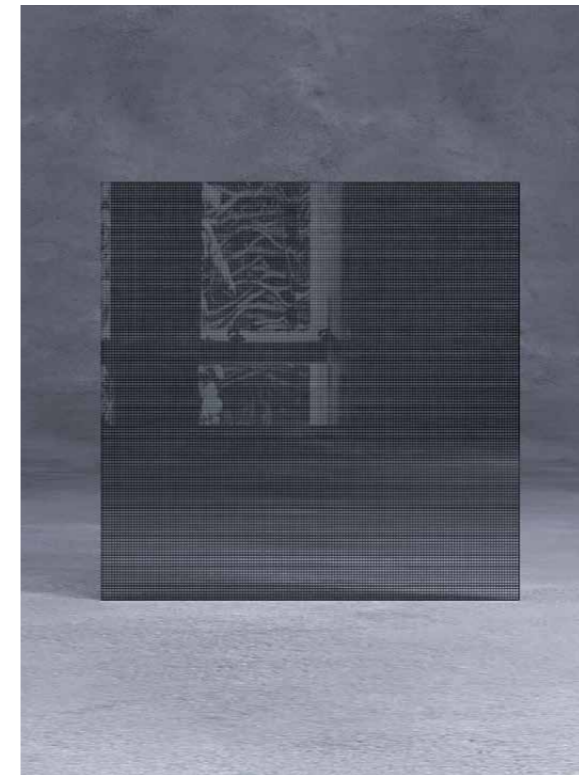

Loft-3

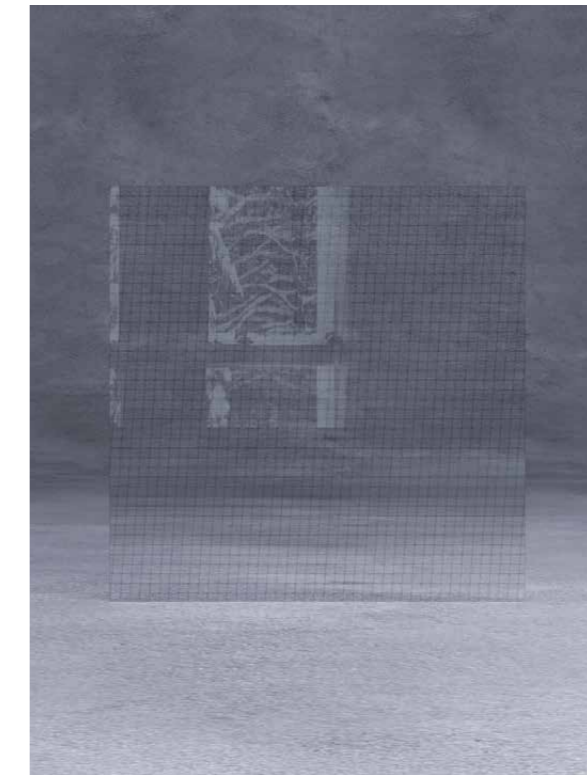

Loft-4

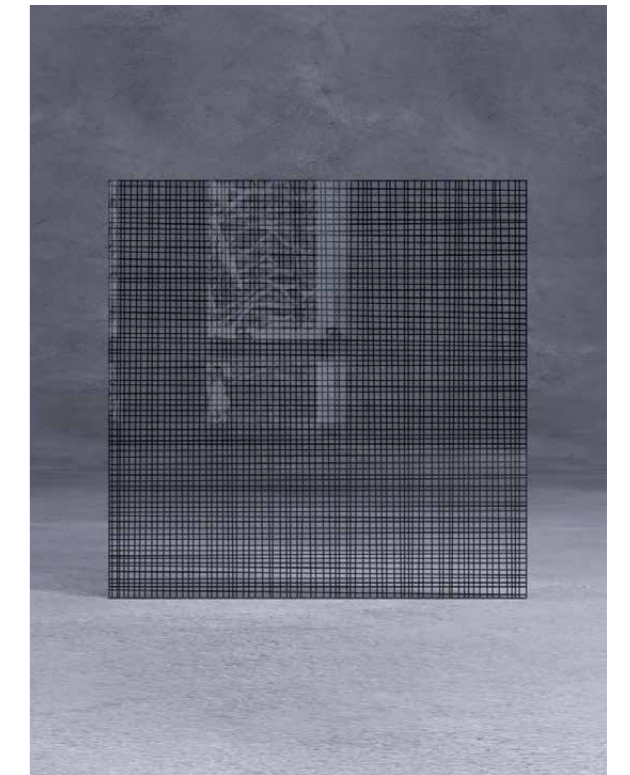

Loft-5

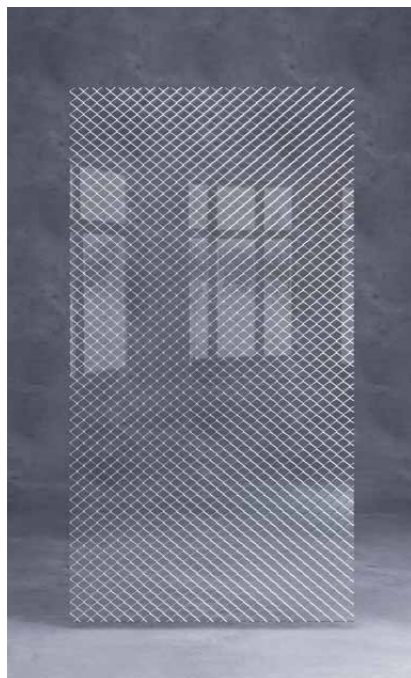

Clear (polymer pattern Chrome)
Klar (Polymermuster Chrom)

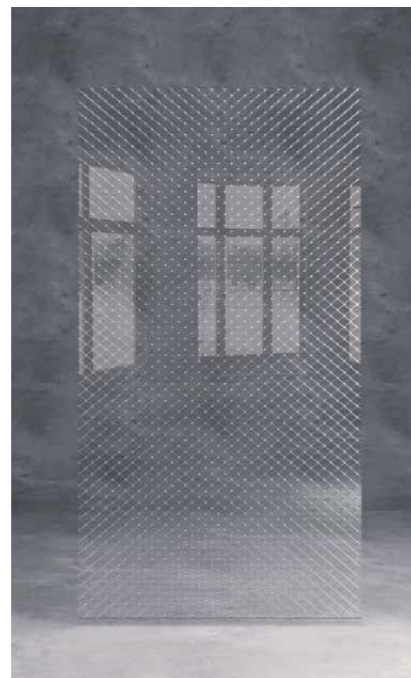

Clear (polymer pattern Transparent)
Klar (Polymermuster Transparent)

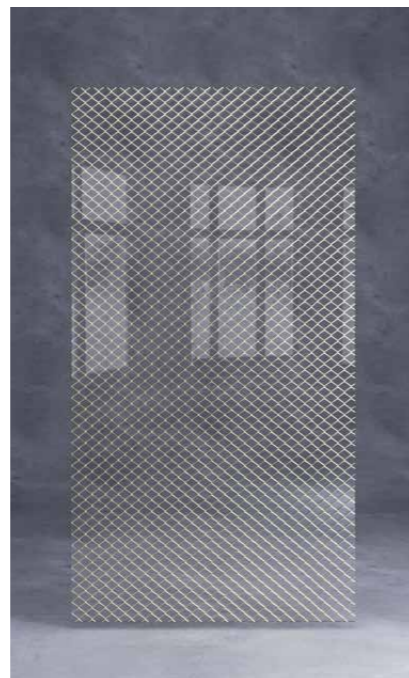

Clear (polymer pattern Gold)
Klar (Polymermuster Gold)

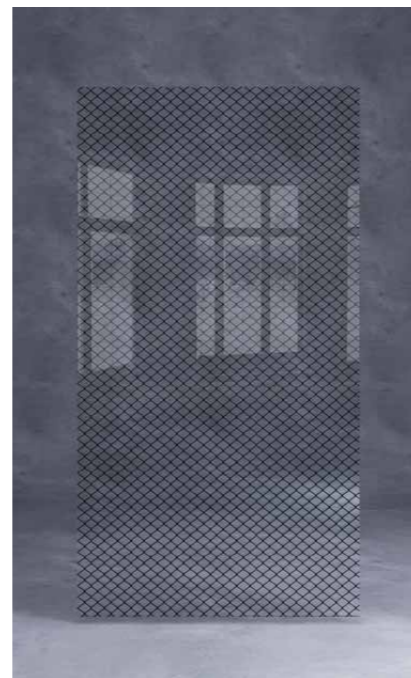

Clear (polymer pattern Black)
Klar (Polymermuster Schwarz)

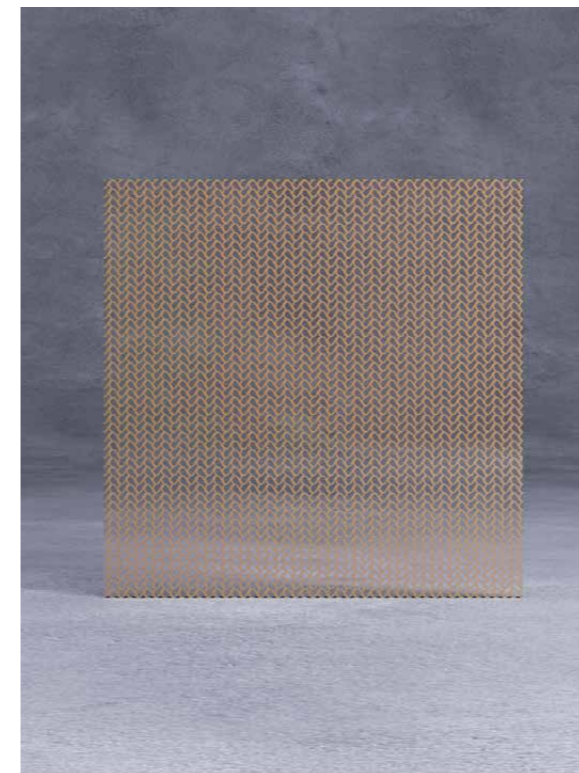

Loft-6

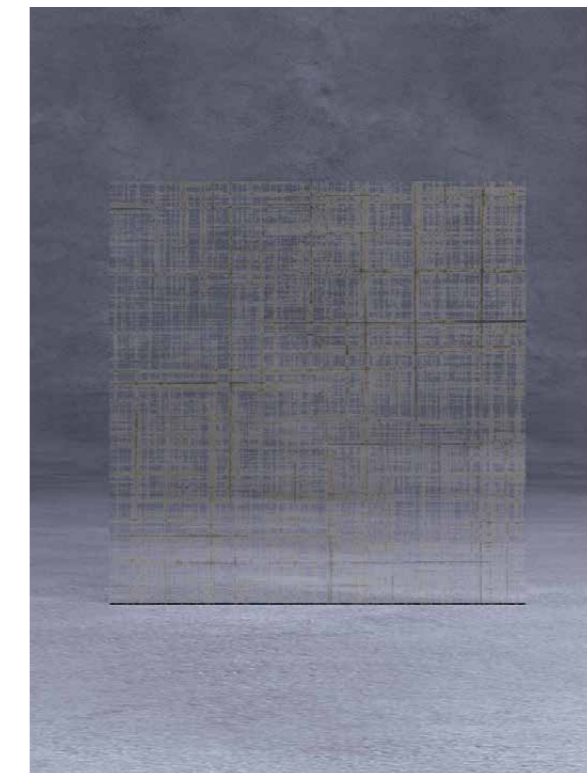

Loft-7

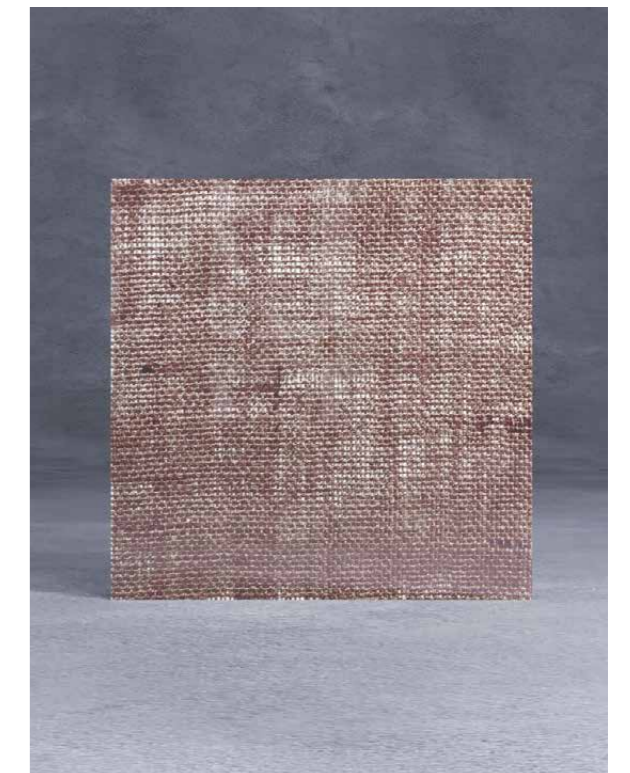

Loft-8



CABINET FRAMES
AND ACCESSORIES

KORPUSSE
UND ZUBEHÖR

MELAMINE FACED CHIPBOARD FOR CABINET FRAMES

MELAMINBESCHICHTETE SPANPLATTE FÜR KORPUSSE

EN

Available as material for cabinet fronts
Thickness 18mm
PVC edgeband in matching color

DE

Als Frontmaterial verfügbar
Plattenstärke 18mm
PVC-Kante in passender Farbe

Premium White
Premium Weiß

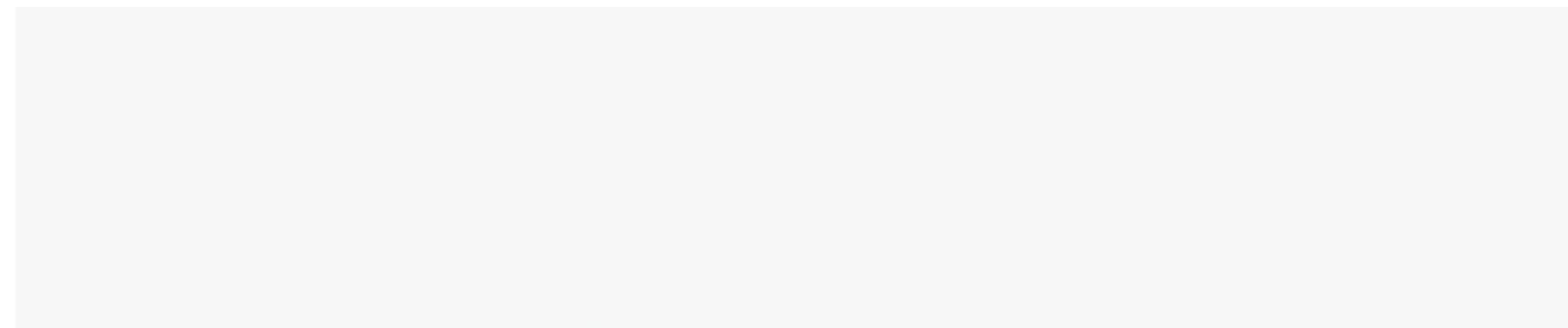

White Wood
Weißes Holz

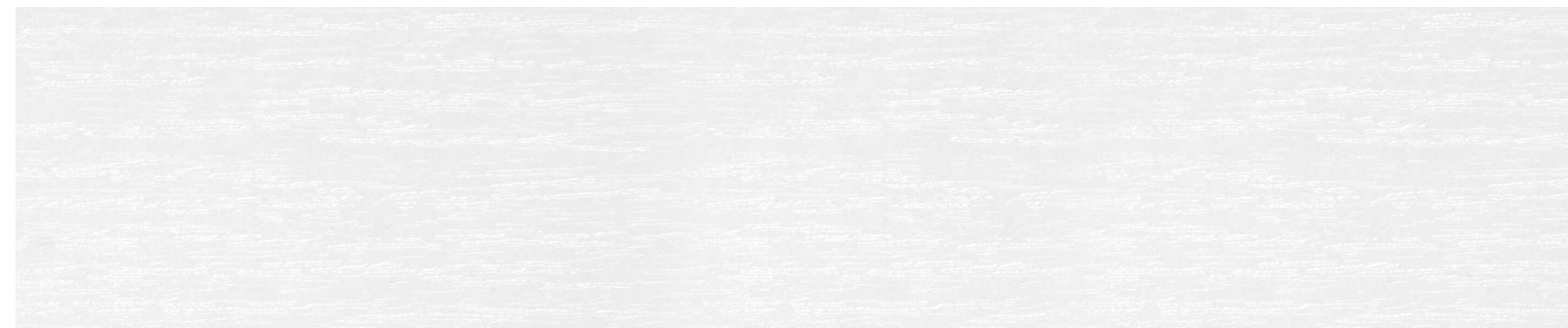

Acacia Akazie



Ashes
Asche

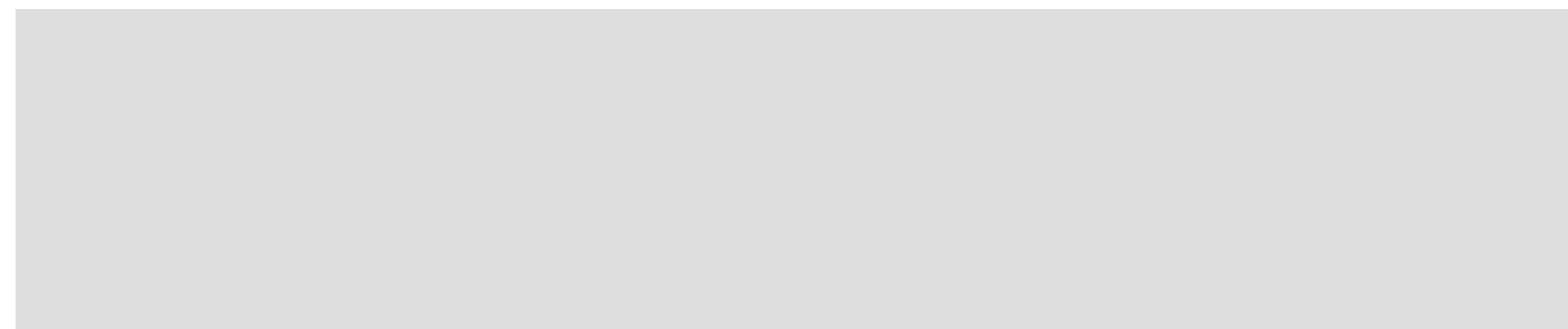

Aluminum
Aluminium



Dust Grey
Staubgrau



Graphite Graphit



Platinum Platin

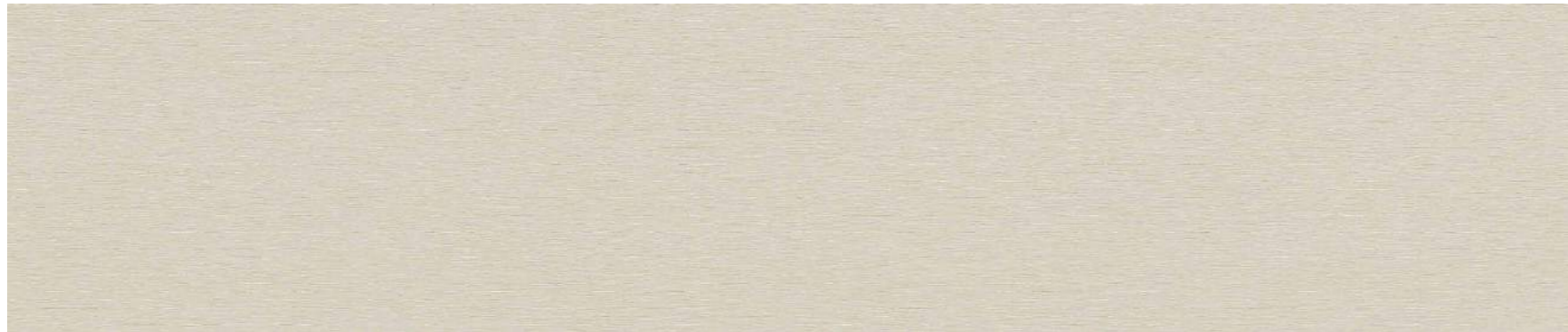

Cream Creme



Gold



Maple Ahorn



Santana



Rustic
Rustikal



Walnut
Nussbaum



Cherry tree
Kirschbaum



Negro



White Gladstone Oak
Gladstone Eiche
Weiß



Oak Sonoma
Eiche Sonoma



Natural Tossini Elm
Tossini Ulme Natur



Truffle Brown
Borneo
Borneo Trüffelbraun



Brown Tossini Elm
Tossini Ulme Braun



Attic Wood
Stadlholz



Magic Magie



PLINTHS AND ACCESSORIES

SOCKEL UND ZUBEHÖR

PVC plinths L=3000mm PVC-Sockel L=3000mm

White Matt
Weiß Matt

H=100, 150mm

White Gloss
Weiß Glanz

H=100, 150mm

Chrome
Chrom

H=100, 150mm

Cream
Crème

H=100, 150mm

Black Gloss
Schwarz Glanz

H=100, 150mm

Ash Esche

H=100mm

Pine Light
Kiefer Hell

H=100mm

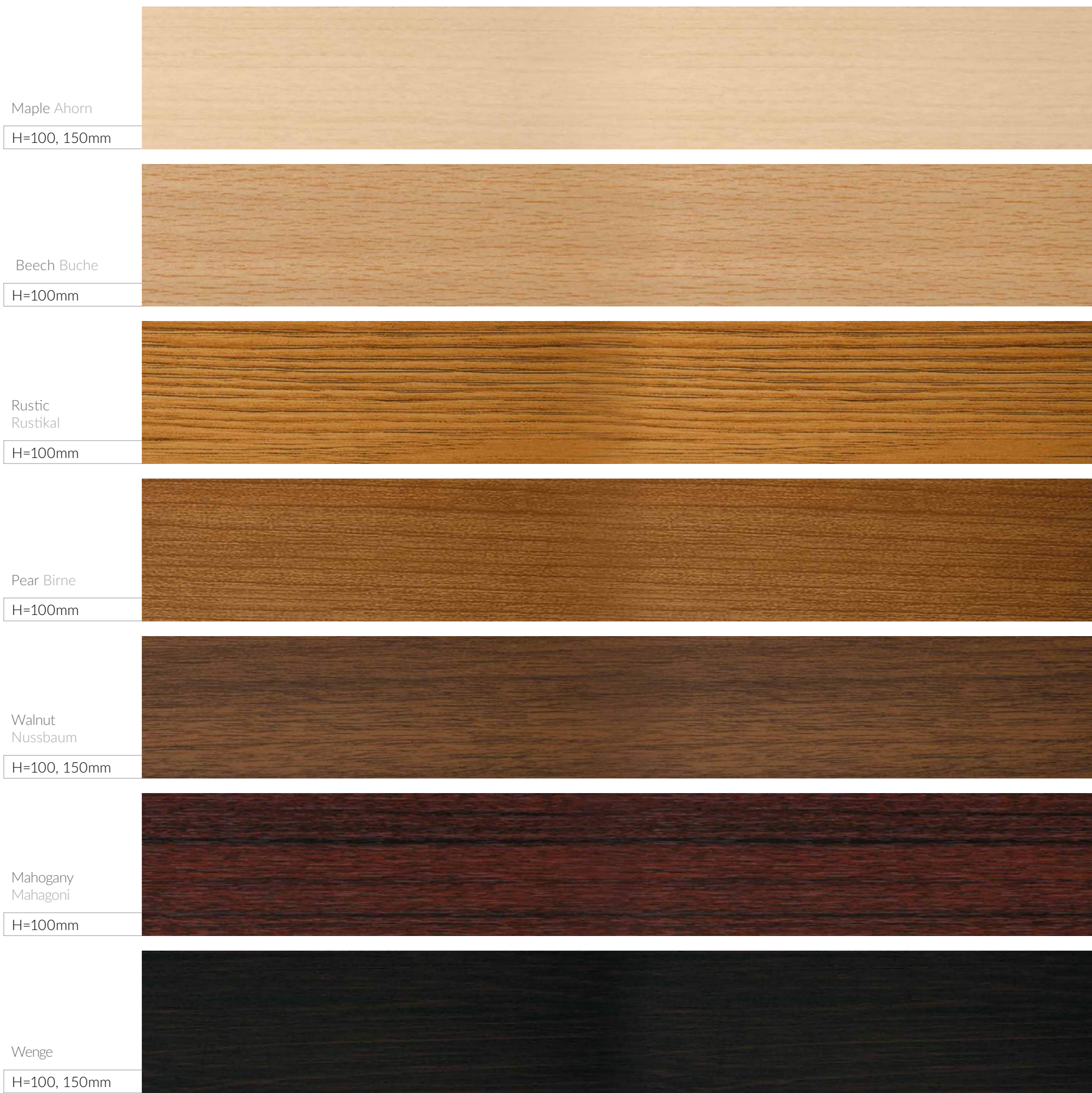

PVC plinth connectors in matching color Verbindler in passender Farbe für PVC-Sockel



Straight joint
Längsverbinder

90° corner connector for external/
internal joints
90° Außen-/Inneneckverbinder

135° corner connector for external/
internal joints
135° Außen-/Inneneckverbinder

End cap
Endkappe

Aluminum plinths L=4000mm Aluminiumsockel L=4000mm



Volpato 20/10.400 AL 07
(H=100mm)

Volpato 20/15.400 AL 07
(H=150mm)

Volpato 21/29.10 AL 07 (H=100mm)
Volpato 21/29.15 AL 07 (H=150mm)

90° aluminum corner connector for external/internal joints
90° Außen-/Inneneckverbinder aus Aluminium

Ventilation grills Lüftungsgitter



Aluminum ventilation grill (60x484mm)
Aluminium-Lüftungsgitter (60x484mm)

Volpato 21/90.449 GA
PVC ventilation grill (65x390mm)
PVC-Lüftungsgitter (65x390mm)

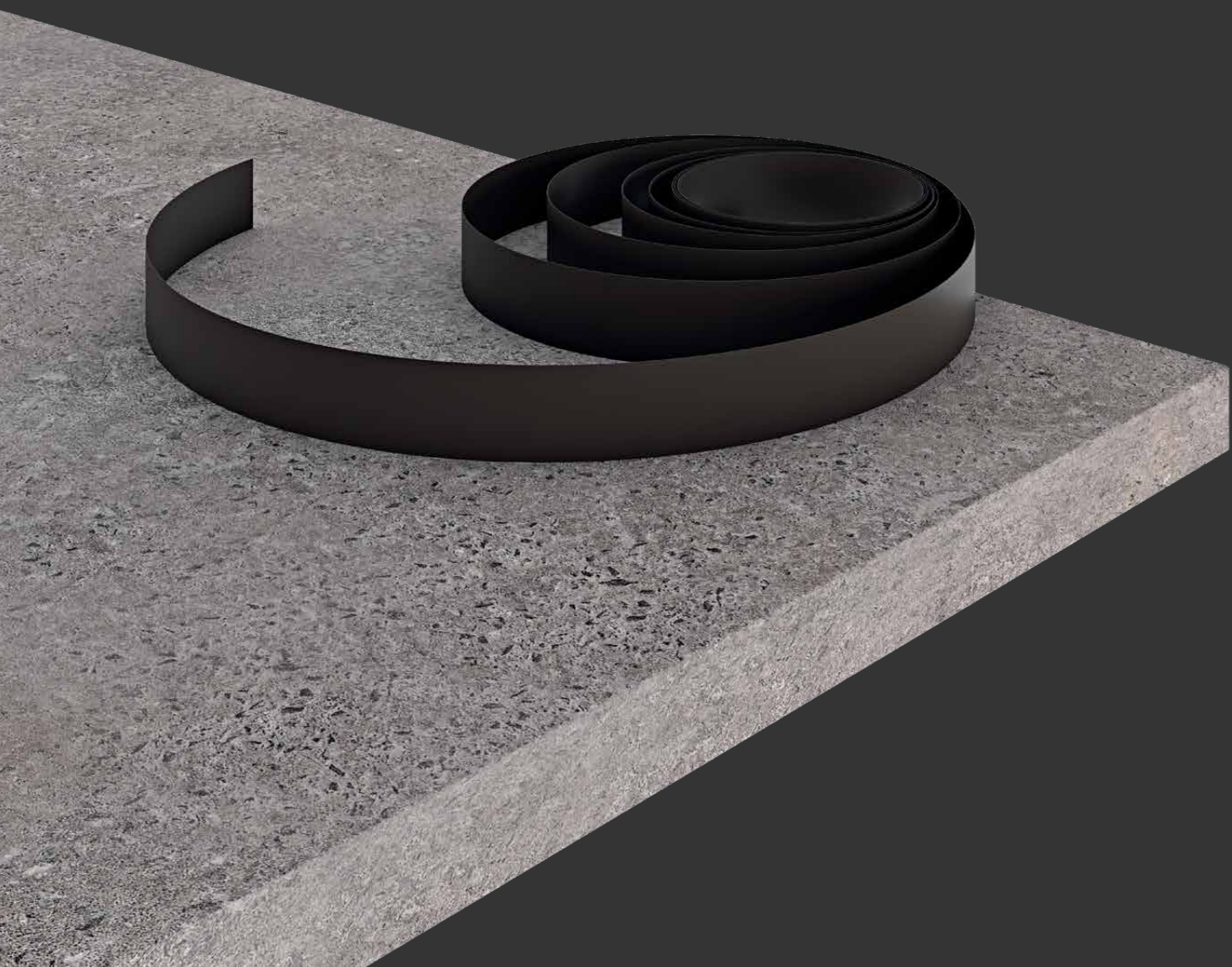

WORKTOP DESIGNS
AND ACCESSORIES

ARBEITSPLETTENDEKOR
E UND ZUBEHÖR

HPL WORKTOP DESIGNS

HPL-ARBEITSPLETTENDEKORE

EN

Available thickness 38, 50mm. Worktops with a thickness of 38mm are moisture-resistant

Available worktop edge finishes: ABS / 3D edgebands, solid wood edge (straight/radius), 2mm thick wood lamella

DE

Die Arbeitsplatten werden in 38 und 50mm Stärke angeboten. Die 38mm starken Arbeitsplatten sind feuchtigkeitsbeständig

Die verfügbaren Arbeitsplattenkanten: ABS-/3D-Kanten, Massivholzleiste (gerade oder gebogen), 2mm starke Holzlamelle



Cascina Pine
Cascina Pinie

ABS edgeband in matching color (38mm)
ABS-Kante in passender Farbe (38mm)



Arizona Oak Grey
Arizona Eiche Grau

ABS edgeband in matching color (38mm)
ABS-Kante in passender Farbe (38mm)



Davos Oak Truffle Brown
Davos Eiche Trüffelbraun

ABS edgeband in matching color (38mm)
ABS-Kante in passender Farbe (38mm)



Lmax=4090mm
Thuja

ABS edgeband in matching color (38mm)
ABS-Kante in passender Farbe (38mm)



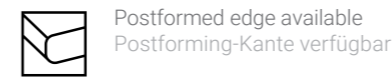

Texture
Struktur





Postformed edge available
Postforming-Kante verfügbar



  Lmax=3590mm Kansas Oak Brown
Kansas Eiche Braun

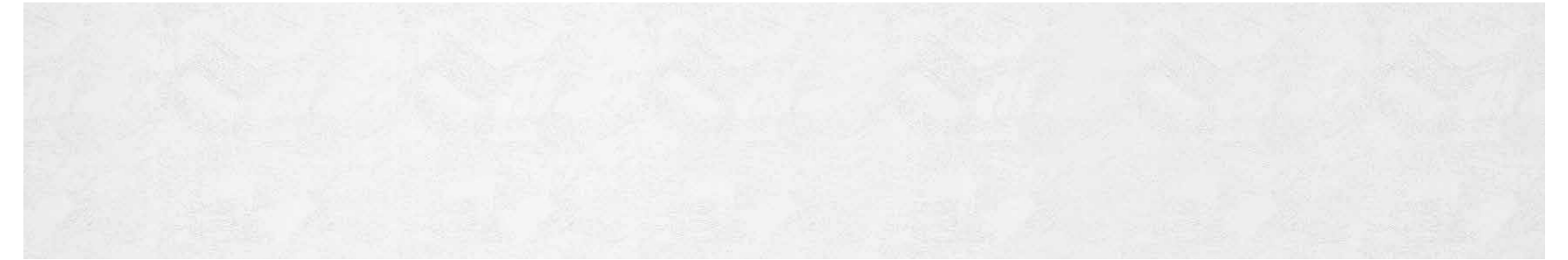

ABS edgeband in matching color (38mm)
ABS-Kante in passender Farbe (38mm)



 Lmax=4090mm Icy



ABS edgeband in matching color (38mm)
ABS-Kante in passender Farbe (38mm)



  Lmax=3040mm
Oak Rigato
Eiche Rigato

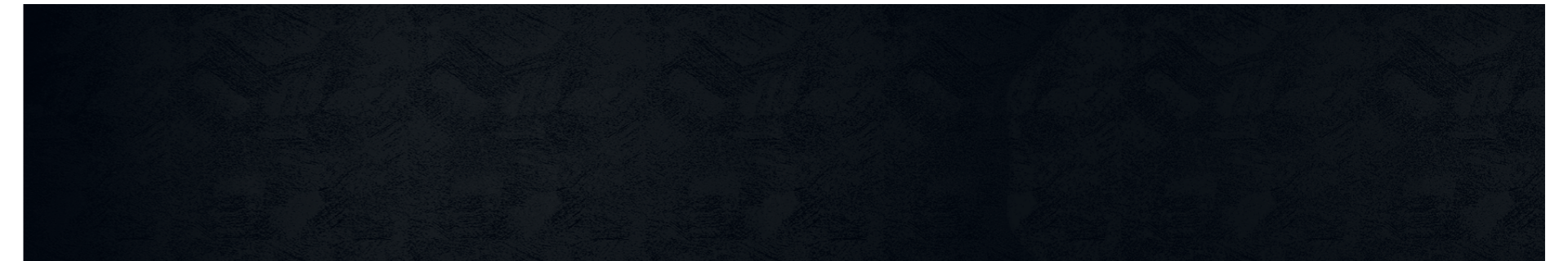

ABS edgeband in matching color (38mm)
ABS-Kante in passender Farbe (38mm)



  Lmax=4090mm Volcano



ABS edgeband in matching color (38mm)
ABS-Kante in passender Farbe (38mm)



  Lmax=3040mm Granite Rockford
Granit Rockford



ABS edgeband in matching color (38mm)
ABS-Kante in passender Farbe (38mm)



  Lmax=4090mm Latteri



ABS edgeband in matching color (38mm)
ABS-Kante in passender Farbe (38mm)



  Lmax=3040mm Riverside



ABS edgeband in matching color (38mm)
ABS-Kante in passender Farbe (38mm)



  Tavn Lmax=4090mm
Taupe



ABS edgeband in matching color (38mm)
ABS-Kante in passender Farbe (38mm)



  Lmax=4090mm Ceneri



ABS edgeband in matching color (38mm)
ABS-Kante in passender Farbe (38mm)

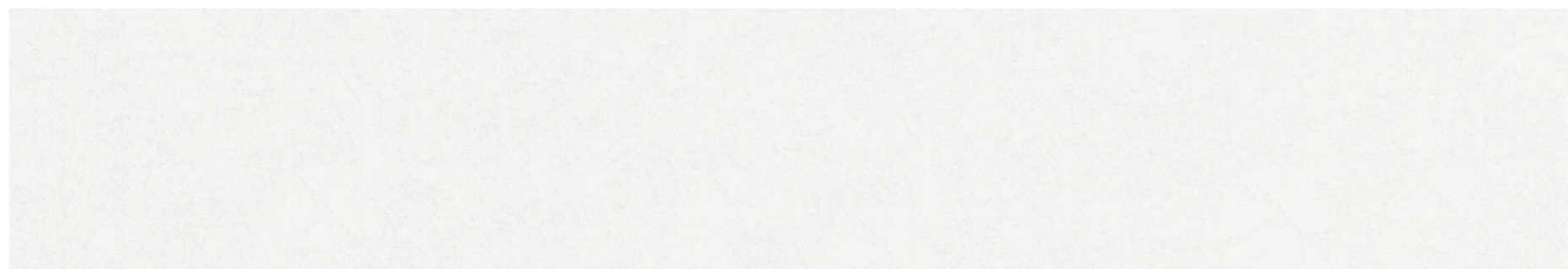

  Chromix Anthracite
Chromix Anthrazit

ABS edgeband in matching color (38mm)
ABS-Kante in passender Farbe (38mm)



  Lmax=4090mm Stone Vix
Stein Wix



ABS edgeband in matching color (38mm)
ABS-Kante in passender Farbe (38mm)



 Valmasino Marble Light Grey
Marmor Valmasino Hellgrau

ABS edgeband in matching color (38mm)
ABS-Kante in passender Farbe (38mm)





  Lmax=4090mm Claystone White
Argillit Weiß

ABS edgeband in matching color (38mm)
ABS-Kante in passender Farbe (38mm)





 Lmax=3040mm Giada Marble Light Blue
Marmor Giada Hellblau



  Lmax=3590mm Chromix Silver
Chromix Silber

ABS edgeband in matching color (38mm)
ABS-Kante in passender Farbe (38mm)



  Lmax=4090mm Ceramic Tessina
Keramik Tessina

ABS edgeband in matching color (38mm)
ABS-Kante in passender Farbe (38mm)

 Texture
Struktur  Postformed edge available
Postforming-Kante verfügbar

 Texture
Struktur  Postformed edge available
Postforming-Kante verfügbar



  Lmax=4090mm
Granite Vercelli
Granit Vercelli

ABS edgeband in matching color (38mm)
ABS-Kante in passender Farbe (38mm)



  Lmax=4090mm
Ferro Bronze

ABS edgeband in matching color (38mm)
ABS-Kante in passender Farbe (38mm)



  Ceramic Terra
Keramik Terra

ABS edgeband in matching color (38mm)
ABS-Kante in passender Farbe (38mm)





  Lmax=3040mm
Ceramic Anthracite
Keramik Anthrazit

ABS edgeband in matching color (38mm)
ABS-Kante in passender Farbe (38mm)

  Texture Struktur  Postformed edge available
Postforming-Kante verfügbar



  Lmax=3590mm Frosted
White
Weiß Bereift

3D edgeband in matching color (38, 50mm)
3D-Kante in passender Farbe (38, 50mm)

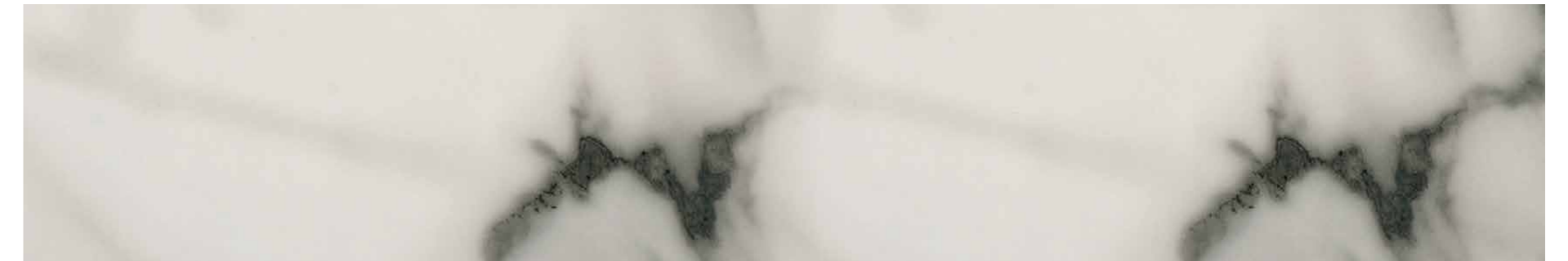

Lmax=3040mm
Marble
Marmor



ABS edgeband in matching color (38mm)
ABS-Kante in passender Farbe (38mm)



 Накарадо Lmax=3590mm
Nacarado

ABS edgeband in matching color (38mm)
ABS-Kante in passender Farbe (38mm)





  Lmax=3040mm Turin Granite
Turiner Granit

ABS edgeband in matching color (38mm)
ABS-Kante in passender Farbe (38mm)



  Texture Struktur  Postformed edge available
Postforming-Kante verfügbar



  Lmax=3590mm Frosted Sand
Sand Bereit

3D edgeband in matching color (38, 50mm)
3D-Kante in passender Farbe (38, 50mm)





  Lmax=3590mm Onyx

3D edgeband in matching color (38, 50mm)
3D-Kante in passender Farbe (38, 50mm)



  Limestone
Kalkstein



  Lmax=3590mm
Jasper
Jaspis

3D edgeband in matching color (38, 50mm)
3D-Kante in passender Farbe (38, 50mm)

  Postformed edge available
Postforming-Kante verfügbar



  Lmax=3590mm
Coral
Koralle



  Lmax=3590mm
Frosted Grey
Grau Bereit



 Lmax=3590mm Galicia

ABS edgeband in matching color (38mm)
ABS-Kante in passender Farbe (38mm)



Lmax=3040mm Breccia
Brekzie

ABS edgeband in matching color (38mm)
ABS-Kante in passender Farbe (38mm)

 Postformed edge available
Postforming-Kante verfügbar

Matt  Gloss Glanz 



 Bronze Black
Bronze Schwarz



Snow Black

3D edgeband in matching color (38mm)
3D-Kante in passender Farbe (38mm)



 Dark Dust
Staub Dunkel

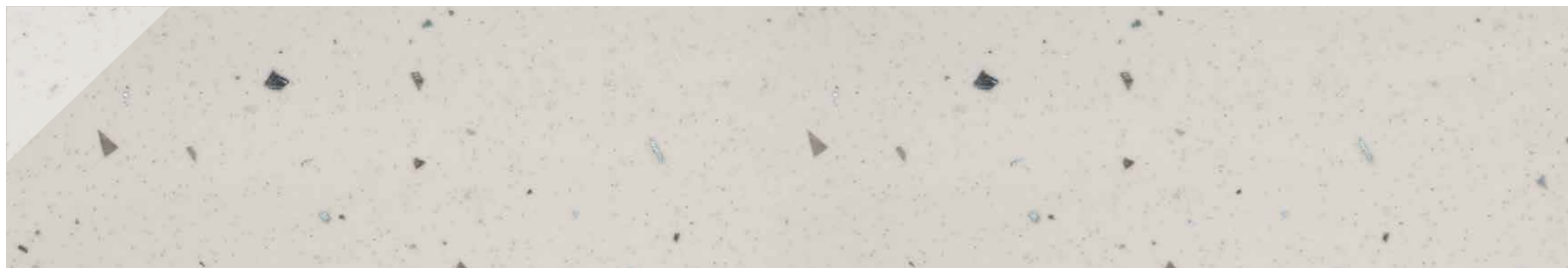

Lmax=3590mm Snow
White

3D edgeband in matching color (38mm)
3D-Kante in passender Farbe (38mm)

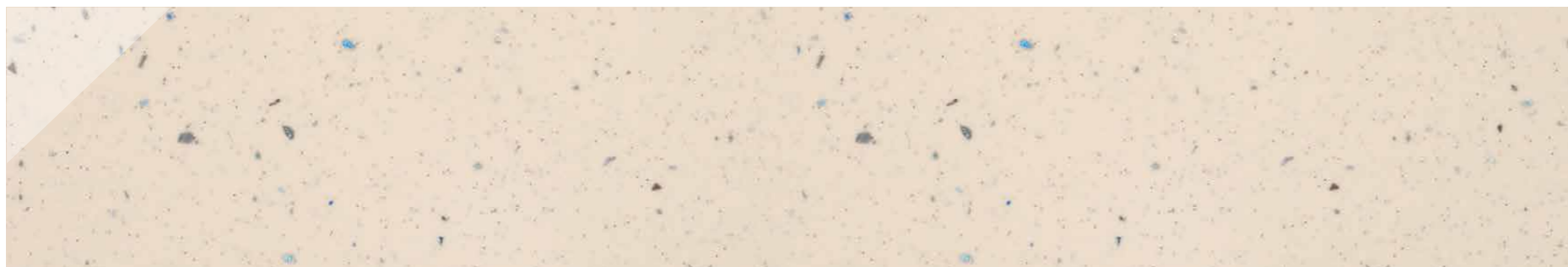

Lmax=3590mm Snow Milky

3D edgeband in matching color (38mm)
3D-Kante in passender Farbe (38mm)



Texture
Struktur



Postformed edge available
Postforming-Kante verfügbar

Matt



Gloss Glanz



Texture
Struktur



Postformed edge available
Postforming-Kante verfügbar

Matt

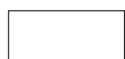

Gloss Glanz



WORKTOPS. CERAMIC ARBEITSPLETTEN. KERAMIK

Solid ceramic worktops Arbeitsplatten aus einem Stück Keramik

Thickness 12mm Stärke 12mm
Maximum size 3200x1600mm Maximale Größe 3200x1600mm



Available designs Verfügbare Dekore

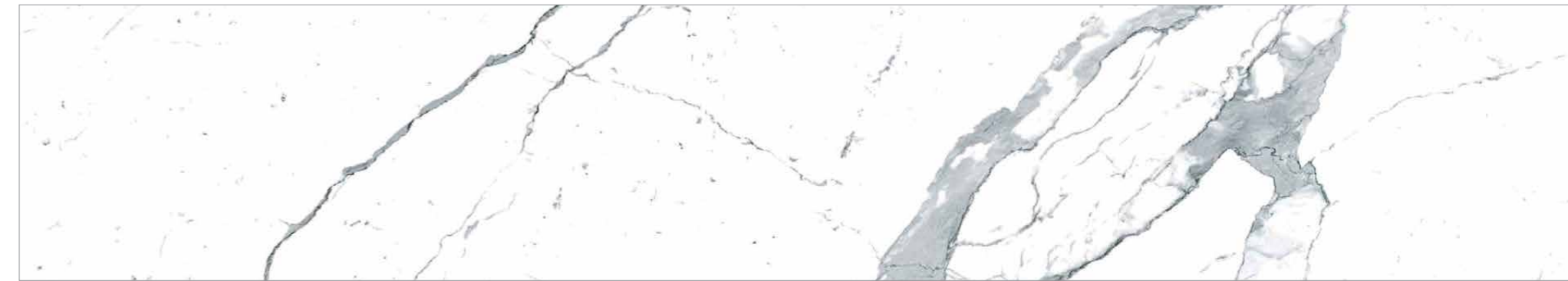

Kankara



Savoia



Boira

Edge profiles Kantenprofile

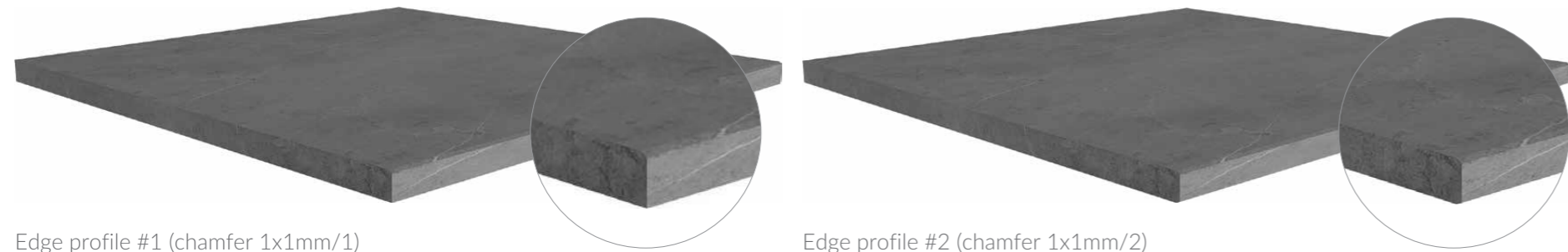

Edge profile #1 (chamfer 1x1mm/1)
Kantenprofil #1 (Abschrägung 1x1mm/1)

Edge profile #2 (chamfer 1x1mm/2)
Kantenprofil #2 (Abschrägung 1x1mm/2)

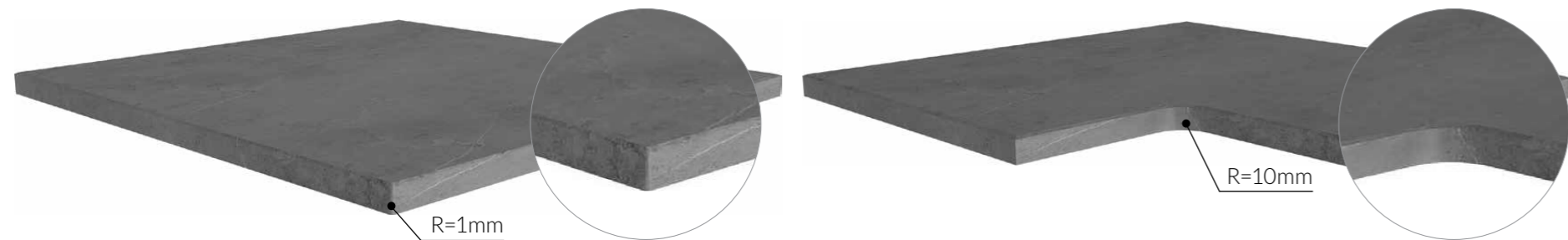

The minimum radius of outer rounding R=1mm
Der Mindestradius der äußeren Rundung R=1mm

The minimum radius of inner rounding R=10mm
Der Mindestradius der inneren Rundung R=10mm

Composite ceramic worktops Zusammengesetzte Keramikarbeitsplatten

Thickness min. 20mm Stärke mind. 20mm
Maximum size 2995x995mm Maximale Größe 2995x995mm

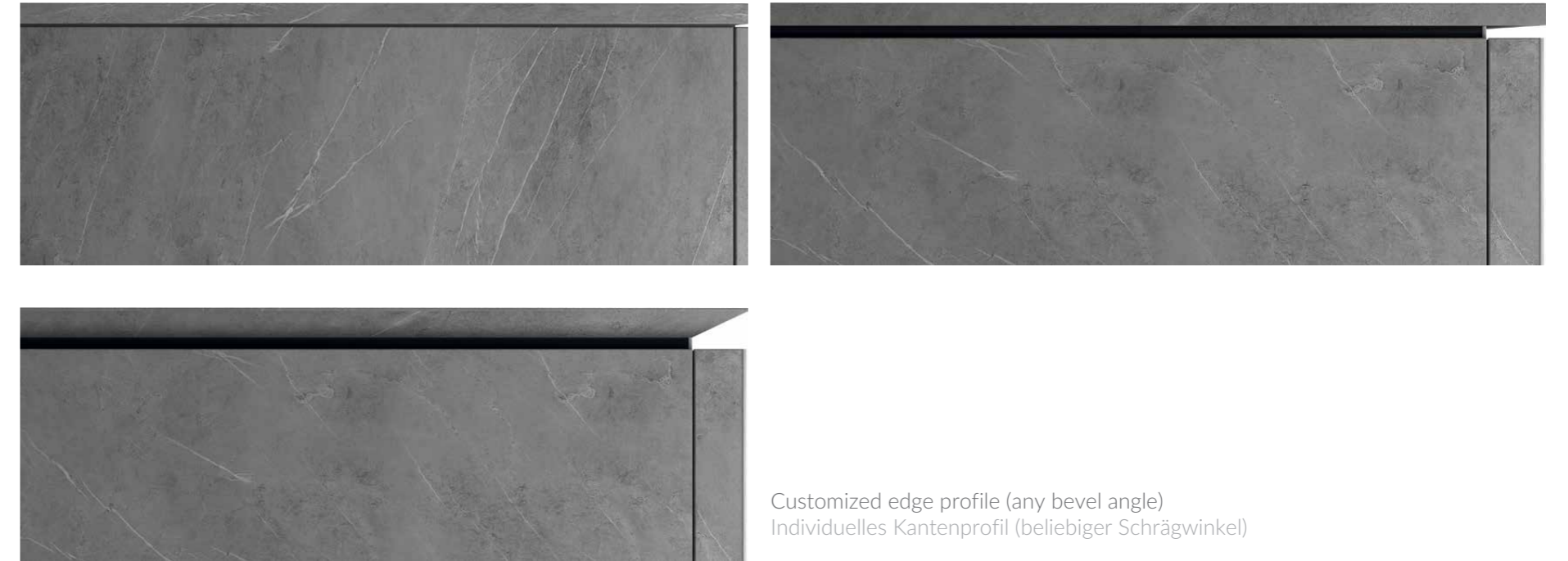

Customized edge profile (any bevel angle)
Individuelles Kantenprofil (beliebiger Schrägwinkel)

Composite worktop. Cross section Zusammengesetzte Arbeitsplatte. Querschnitt

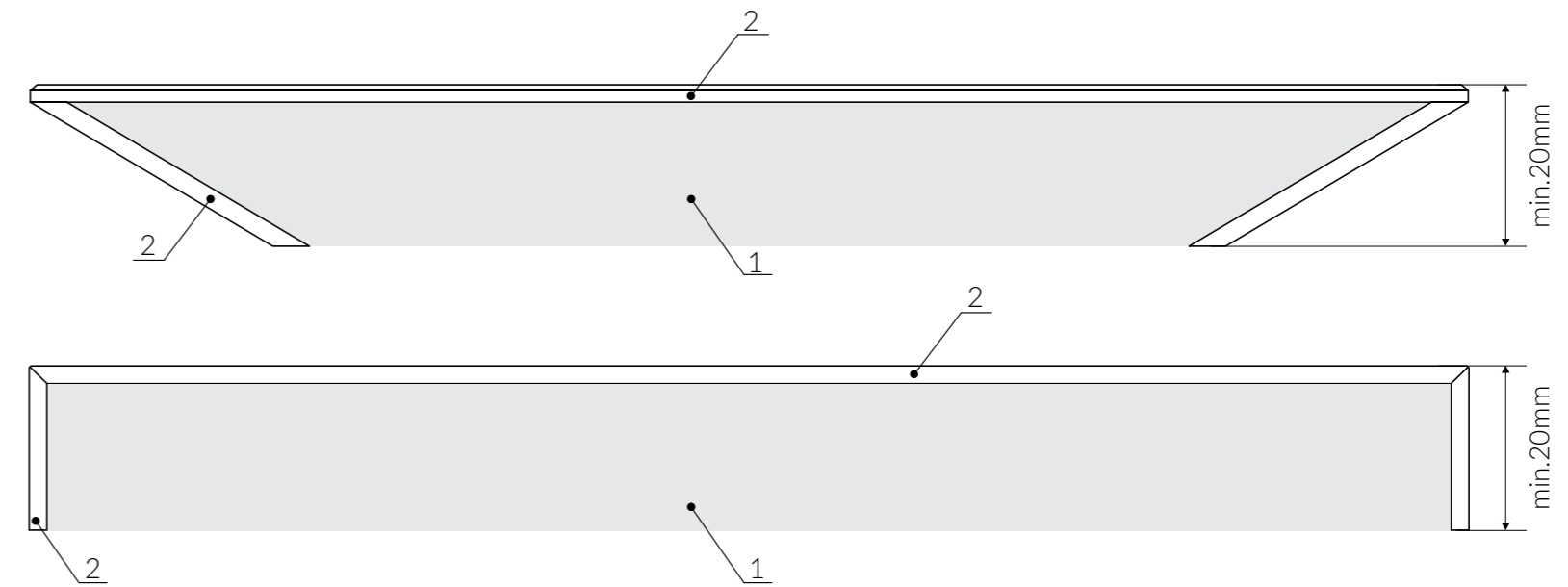

1 - MDF/Chipboard MDF/Spanplatte
2 - Ceramic Keramik

No outer/inner roundings are available for composite worktops. After technical approval it is possible to produce worktops with customized edge profile.

Keine äußeren/inneren Rundungen sind für zusammengesetzte Arbeitsplatten möglich. Nach technischer Genehmigung ist es möglich, Arbeitsplatten mit individuellem Kantenprofil zu fertigen.

Available designs Verfügbare Dekore



Boira



Kankara



Savoia

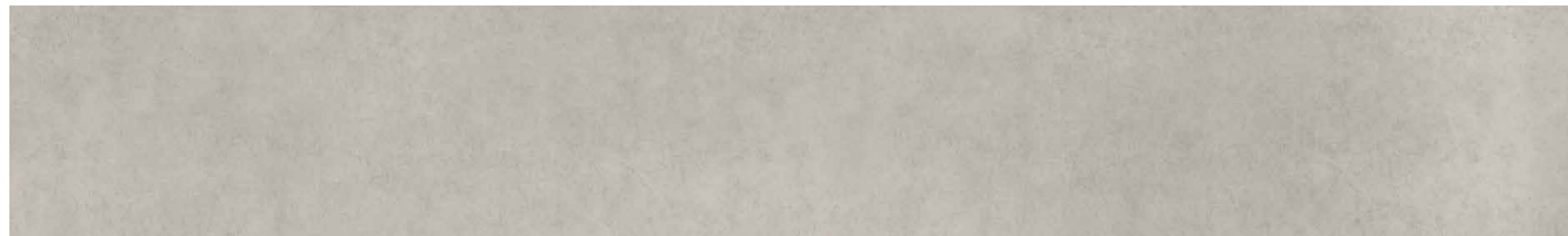

Vilma Wilma

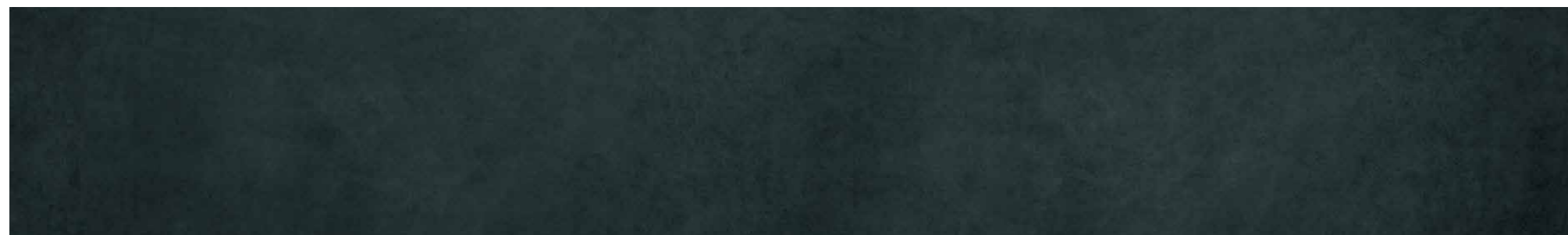

Foketa

Ceramic wall edging strip (L=3200mm) Keramik-Wandabschlussleiste (L=3200mm)

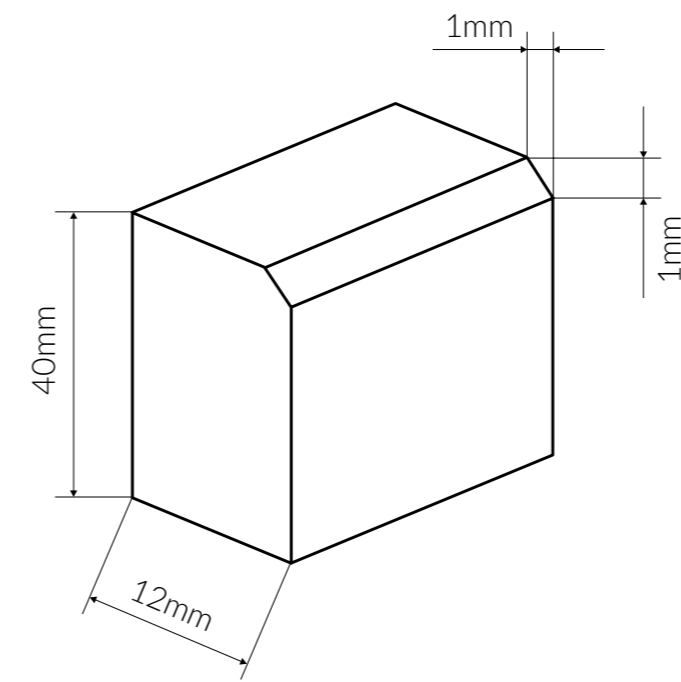

Available in Kankara, Savoia, Boira, Vilma, Foketa standard designs
Verfügbar in Standarddekoren Kankara, Savoia, Boira, Vilma, Foketa

ABS EDGE BANDS ABS-KANTEN



ABS Oak Rigato
ABS Eiche Rigato



ABS Granite Rockford
ABS Granit Rockford



ABS Riverside



ABS Icy



ABS Volcano



ABS Latteri



ABS Taupe



ABS Ceneri



ABS Cascina Pine
ABS Cascina Pinie



ABS Arizona Oak Grey
ABS Arizona Eiche Grau



ABS Davos Oak Truffle Brown
ABS Davos Eiche Trüffelbraun



ABS Thuja

For 38mm thick worktops Für 38mm starke Arbeitsplatten



ABS Kansas Oak Brown
ABS Kansas Eiche Braun



ABS Stone Vix
ABS Stein Wix



ABS Claystone White
ABS Argillit Weiß

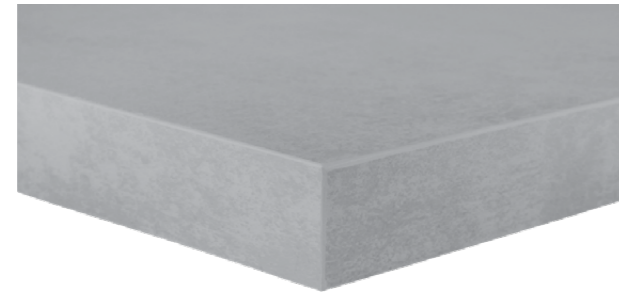

ABS Chromix Silver
ABS Chromix Silber



ABS Chromix Anthracite
ABS Chromix Anthrazit



ABS Valmasino Marble Light Grey
ABS Marmor Walmasino Hellgrau



ABS Ceramic Tessina
ABS Keramik Tessina



ABS Granite Vercelli
ABS Granit Vercelli



ABS Ferro Bronze



ABS Ceramic Terra
ABS Keramik Terra



ABS Ceramic Anthracite
ABS Keramik Anthrazit



ABS Marble
ABS Marmor

For 38mm thick worktops Für 38mm starke Arbeitsplatten



ABS Nacarado



ABS Turin Granite
ABS Turiner Granit



ABS Galicia



ABS Breccia
ABS Brekzie



ABS Black
ABS Schwarz

Для столешниц толщиной 38мм For 38mm thick worktops Für 38mm starke Arbeitsplatten

HIGH-GLOSS 3D EDGE BANDS

HCHGLÄNZENDE 3D-KANTEN

For 38 and 50mm thick worktops Für 38 und 50mm starke Arbeitsplatten



3D Frosted White
3D Weiß bereift



3D Onyx



3D Frosted Sand 3D
Sand bereift



3D Jasper
3D Jaspis



3D White
3D Weiß



3D Bronze



3D Plywood
3D Furnier



3D Silver
3D Silber

For 38mm thick worktops Für 38mm starke Arbeitsplatten



3D Snow Milky



3D Snow White



3D Snow Black

EN

3D edgebands of crystal clear acrylic with design on the back

DE

3D-Kanten aus glasklarem Acryl mit rückseitig aufgebrachtem Dekor

L-SHAPED WALL EDGING STRIPS (L=4000mm)

L-FÖRMIGE WANDABSCHLUSSLEISTEN (L=4000mm)



Oak Rigato
Eiche Rigato



Granite Rockford
Granit Rockford



Riverside



Icy



Volcano



Latteri



Taupe



Ceneri



Cascina Pine
Cascina Pinie



Arizona Oak Grey
Arizona Eiche Grau



Davos Oak Truffle Brown
Davos Eiche Trüffelbraun



Thuja



Kansas Oak Brown
Kansas Eiche Braun



Stone Vix
Stein Wix



Claystone White
Argillit Weiß



Chromix Silver
Chromix Silber

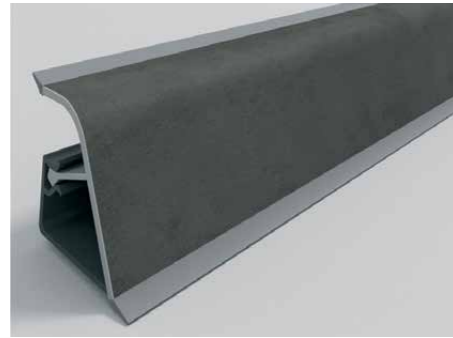

Chromix Anthracite
Chromix Anthrazit



Valmasino Marble Light Grey
Marmor Valmasino Hellgrau



Giada Marble Light Blue
Marmor Giada Hellblau



Ceramic Tessina
Keramik Tessina



Coral
Koralle



Frosted Grey
Grau Bereift



Galicia



Breccia
Brekzie



Granite Vercelli
Granit Vercelli



Ferro Bronze



Ceramic Terra
Keramik Terra



Ceramic Anthracite
Keramik Anthrazit



Bronze Black
Bronze Schwarz

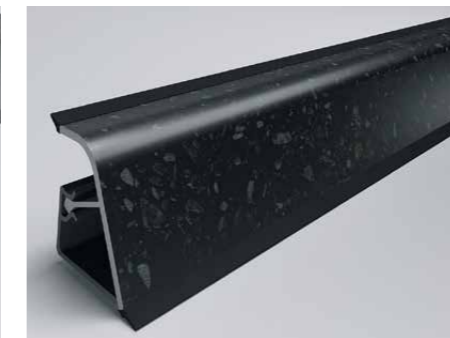

Dark Dust
Staub Dunkel



Snow White



Snow Milky



Frosted White
Weiß Bereift



Marble
Marmor



Nacarado



Turin Granite
Turiner Granit



Snow Black



Aluminum
Aluminium



Frosted Sand
Sand Bereift



Onyx



Limestone
Kalkstein

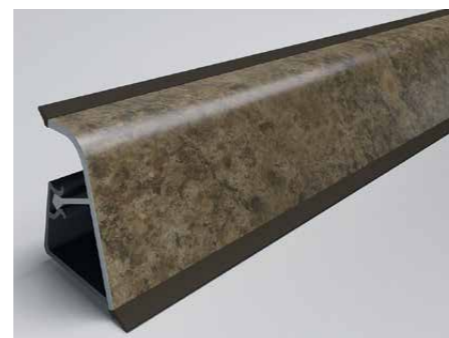

Jasper
Jaspis

TRIANGULAR WALL EDGING STRIPS (L=3000mm)

DREIECKIGE WANDABSCHLUSSLEISTEN (L=3000mm)



Chrome
Chrom



Cream
Crème



White Gloss
Weiß Glanz



Black Gloss
Schwarz Glanz

RECTANGULAR WALL EDGING STRIP (L=4200mm)

RECHTECKIGE WANDABSCHLUSSLEISTE (L=4200mm)

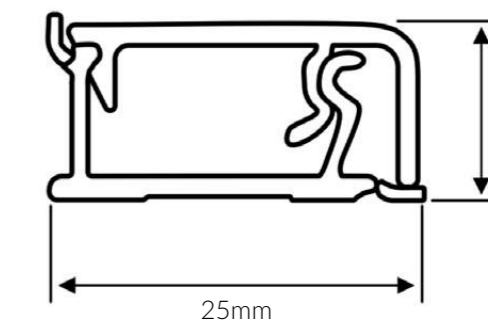
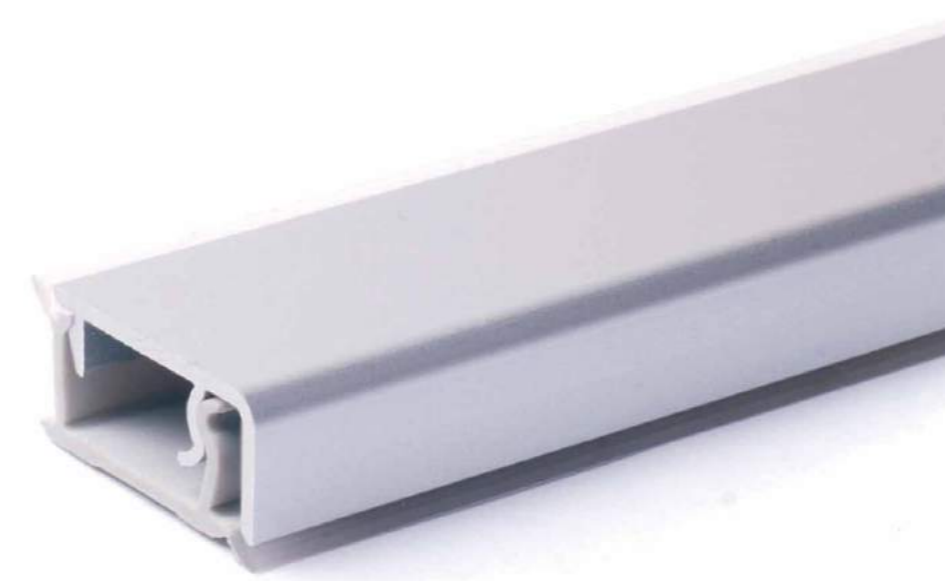

Volpato 50/62.420 AL 07
Brushed aluminum
Aluminium gebürstet

Worktop edging strips Verbindungsschienen und Endkappen



Straight joint strip (L=600mm)
Schiene für gerade Verbindung (L=600mm)



Trim end cap (L=600mm)
Endkappe (L=600mm)



Corner joint strip (L=600mm)
Eckverbindungsschiene (L=600mm)

For standard 38mm thick worktops
Material: Aluminum (matt)

Für 38mm starke Standardarbeitsplatten Material:
Aluminium (matt)



ACCESSORIES AND
HARDWARE

ZUBEHÖR
UND BESCHLÄGE

HANDLES, KNOBS, PROFILES
GRIFFE, KNÖPFE, PROFILE

Knobs Knöpfe



24087.85



24134.25



24231.83



24316.83



GP20-MLK



GP20-WHT



47-01



47-11



673-C2



784-T2



77-D1



77-C2



77-T4



77-T3



Porcelain Bronze
Porzellan Bronze



Porcelain Nickel
Porzellan Nickel

Handles Griffe



15134.25 (64mm hole spacing) (64mm Bohrabstand)
 15134.25 (128mm hole spacing) (128mm Bohrabstand)
 15097.94 (32mm hole spacing) (32mm Bohrabstand)
 15097.94 (96, 160mm hole spacing) (96, 160mm Bohrabstand)



15231.83 (160mm hole spacing) (160mm Bohrabstand)
 15136.83 (128mm hole spacing) (128mm Bohrabstand)
 95-C2 (96mm hole spacing) (96mm Bohrabstand)
 95-D1 (96mm hole spacing) (96mm Bohrabstand)



CL374 (32mm hole spacing) (32mm Bohrabstand)
 CL374 (128, 160mm hole spacing) (128, 160mm Bohrabstand)
 CL409 (192mm hole spacing) (192mm Bohrabstand)
 18063.85 (128mm hole spacing) (128mm Bohrabstand)



RS448-01 (128mm hole spacing) (128mm Bohrabstand)
 RS448-04 (128mm hole spacing) (128mm Bohrabstand)
 753-M5 (192mm hole spacing) (192mm Bohrabstand)
 753-H3 (192mm hole spacing) (192mm Bohrabstand)



RS293-06 (160mm hole spacing) (160mm Bohrabstand)
 RS293-14 (160mm hole spacing) (160mm Bohrabstand)
 RS219 (160, 224, 320mm hole spacing) (160, 224, 320mm Bohrabstand)
 15220.34 (width 174mm) (Breite 174mm)



770-02 (160mm hole spacing) (160mm Bohrabstand)
 UZ336 (160, 320, 480mm hole spacing) (160, 320, 480mm Bohrabstand)
 770-F3 (160mm hole spacing) (160mm Bohrabstand)
 770-F3 (320mm hole spacing) (320mm Bohrabstand)



15221.F5 (width 170mm) (Breite 170mm)
 15221.N2 (width 170mm) (Breite 170mm)
 15244.34 (224mm hole spacing) (224mm Bohrabstand)
 15244.N2 (224mm hole spacing) (224mm Bohrabstand)



787-F3 (160mm hole spacing) (160mm Bohrabstand)
 787-F3 (320mm hole spacing) (320mm Bohrabstand)
 17-07 (160mm hole spacing) (160mm Bohrabstand)
 770-02 (320mm hole spacing) (320mm Bohrabstand)



787-02 (160mm hole spacing) (160mm Bohrabstand) 787-02 (320mm hole spacing) (320mm Bohrabstand) 47-11 (128mm hole spacing) (128mm Bohrabstand) 47-01 (128mm hole spacing) (128mm Bohrabstand)



784-T2 (160mm hole spacing) (160mm Bohrabstand) 10-14 Antique copper (160, 224, 320mm hole spacing) (10-14 Antikes Kupfer (160, 224, 320mm Bohrabstand)) 470-G6 (64mm hole spacing) (64mm Bohrabstand) 470-F3 (64mm hole spacing) (64mm Bohrabstand)



RC089-02 RC089-01 11-11 (32, 96mm hole spacing) (32, 96mm Bohrabstand) 11-01 (32, 96mm hole spacing) (32, 96mm Bohrabstand)



777-T2 (32mm hole spacing) (32mm Bohrabstand) 5600-R3 RS286 (160, 192mm hole spacing) (160, 192mm Bohrabstand) 19-25 (128mm hole spacing) (128mm Bohrabstand)



54-A1 (128mm hole spacing) (128mm Bohrabstand) 1001-A1D1 (96mm hole spacing) (96mm Bohrabstand) 71-T3 (128mm hole spacing) (128mm Bohrabstand) 71-T4 (128mm hole spacing) (128mm Bohrabstand)



514-D1 (128mm hole spacing) (128mm Bohrabstand) 514-E8 (128mm hole spacing) (128mm Bohrabstand) 503-D1 (128mm hole spacing) (128mm Bohrabstand) 503-E8 (128mm hole spacing) (128mm Bohrabstand)



619-C2 (128mm hole spacing) (128mm Bohrabstand) S2414 (160mm hole spacing) (160mm Bohrabstand) S2995 (192mm hole spacing) (192mm Bohrabstand)



S054 (192mm hole spacing) (192mm Bohrabstand) Porcelain Bronze (96mm hole spacing) (Porzellan Bronze (96mm Bohrabstand)) Porcelain Nickel (96mm hole spacing) (Porzellan Nickel (96mm Bohrabstand)) 01-04 (128mm hole spacing) (128mm Bohrabstand)



153-03 (128, 160mm hole spacing) (128, 160mm Bohrabstand) 153-01 (128, 160mm hole spacing) (128, 160mm Bohrabstand) 08-04 (128, 160mm hole spacing) (128, 160mm Bohrabstand) 08-06 (128, 160mm hole spacing) (128, 160mm Bohrabstand)



U-06
(160, 256, 416mm hole spacing)
(160, 256, 416mm Bohrabstand)

10-04 Chrome
(160, 224, 320, 448mm hole spacing)
10-04 Chrom
(160, 224, 320, 448mm Bohrabstand)

10-06 Satin
(160, 224, 320, 448mm hole spacing)
10-06 Satin
(160, 224, 320, 448mm Bohrabstand)

10-08 Aluminum
(160, 224, 320, 448mm hole spacing)
10-08 Aluminium
(160, 224, 320, 448mm Bohrabstand)

Decorative hinges Dekorscharniere



Faux butt hinge WCR250-H4 Scharnier
(Imitation) WCR250-H4



Faux butt hinge WCR250-E8 Scharnier
(Imitation) WCR250-E8



Faux butt hinge WCR250-D1 Scharnier
(Imitation) WCR250-D1



Faux butt hinge WCR250-T2
Scharnier (Imitation) WCR250-T2



Strap hinge WCR100-T2
Kreuzgehänge WCR100-T2

Handle strip Griffleiste



0005 (width 147, 197, 297, 397, 447, 497, 597, 797, 897mm)
(Breite 147, 197, 297, 397, 447, 497, 597, 797, 897mm)

Concealed pull grips Verdeckte griffleisten

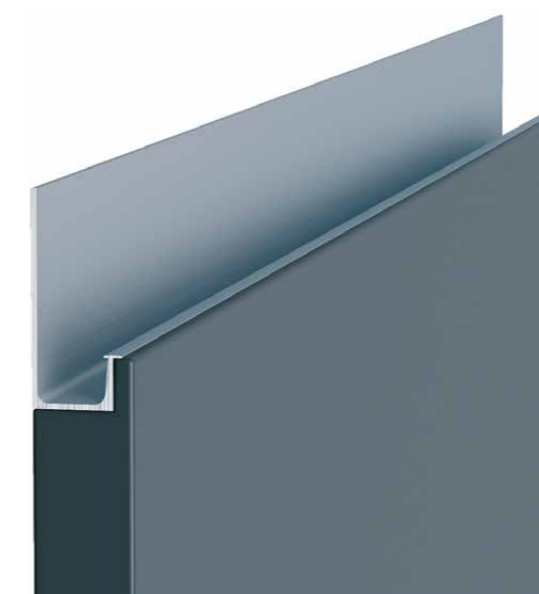

C-1 for base units
C-1 für Unterschränke



C-2 for wall units
C-2 für Hängeschränke

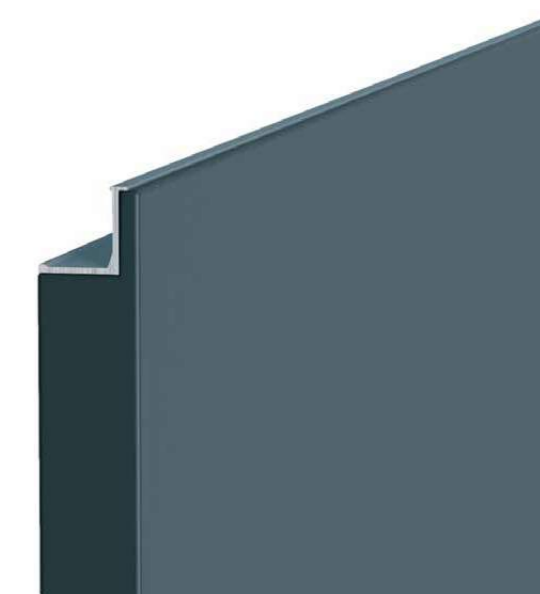

C-3 for base and wall units
C-3 für Hänge- und Unterschränke

Available for fronts of acrylic, HPL, glass, wood veneer, decorative panels Timber, Synchron, Smart
Verfügbar für Fronten aus Acryl, HPL, Glas, Holz furnier, Dekorplatten Timber, Synchron, Smart

Available for fronts of acrylic, HPL, decorative panels Timber, Synchron, Smart
Verfügbar für Fronten aus Acryl, HPL, Dekorplatten Timber, Synchron, Smart

Handle recesses Griffmulden



KV-1 for base units
KV-1 für Unterschränke



KV-2 for wall units
KV-2 für Hängeschränke

Available for veneered fronts and fronts of lacquered MDF
Verfügbar für Furnierfronten und Fronten aus lackierter MDF-Platte

Profiles Profile

Single-rounded horizontal profile for base cabinets
Horizontales Profil für Unterschränke, einseitig gerundet



Volpato Gola 80/G12 AL 07 L=4200mm



Volpato Gola 80/G12 AL 09 L=4200mm



Volpato Gola 80/G12 AL 52 L=4200mm

Double-rounded horizontal profile for base cabinets
Horizontales Profil für Unterschränke, beidseitig gerundet



Volpato Gola 80/G13 AL 07 L=4200mm



Volpato Gola 80/G13 AL 09 L=4200mm



Volpato Gola 80/G13 AL 52 L=4200mm

AL 07 Brushed aluminum Aluminium gebürstet AL 09 Black Schwarz AL 52 White Weiß

Single-rounded vertical profile for tall cabinets
Vertikales Profil für Hochschränke, einseitig gerundet



Volpato Gola 80/G21 AL 07 L=4700mm



Volpato Gola 80/G21 AL 09 L=4700mm



Volpato Gola 80/G21 AL 52 L=4700mm

Double-rounded vertical profile for tall cabinets
Vertikales Profil für Hochschränke, beidseitig gerundet



Volpato Gola 80/G15 AL 07 L=4700mm



Volpato Gola 80/G15 AL 09 L=4700mm



Volpato Gola 80/G15 AL 52 L=4700mm

Horizontal profile with rubber seal for wall cabinets
Horizontales Profil mit Dichtung für Hängeschränke



Volpato Gola 80/G14 AL 07 L=4200mm

InnoTech* Color Silver Farbe Silber

DRAWER SYSTEMS AND INTERIOR ORGANIZATIONS

SCHUBKASTENSYSTEME UND INNENORGANISATIONEN



Drawer system, rear panel height 54mm
Nominal runners length 470mm
Drawer side height 54mm

Schubkastensystem, Rückwandhöhe 54mm
Nennlänge der Führungen 470mm
Zargenhöhe 54mm



Drawer system, rear panel height 70mm Nominal runners length 260, 350, 420, 470mm
Drawer side height 70mm

Schubkastensystem, Rückwandhöhe 70mm
Nennlänge der Führungen 260, 350, 420, 470mm
Zargenhöhe 70mm



Internal drawer system, rear panel height 70mm
Nominal runners length 260, 350, 420, 470mm
Drawer side height 70mm

Innenschubkastensystem, Rückwandhöhe 70mm
Nennlänge der Führungen 260, 350, 420, 470mm
Zargenhöhe 70mm



Pot-and-pan drawer system with railing, rear panel height 144mm
Nominal runners length 260, 350, 420, 470mm
Drawer side height 144mm

Frontauszug mit Reling, Rückwandhöhe 144mm
Nennlänge der Führungen 260, 350, 420, 470mm
Zargenhöhe 144mm



Internal pot-and-pan drawer system with railing, rear panel height 144mm
Nominal runners length 260, 350, 420, 470mm
Drawer side height 144mm

Innenfrontauszug mit Reling, Rückwandhöhe 144mm
Nennlänge der Führungen 260, 350, 420, 470mm
Zargenhöhe 144mm



XXL under-oven drawer
Nominal runners length 470mm
Cabinet width 600mm
Plinth height 100mm

Großraumauszug für Herdunterbau
Nennlänge der Führungen 470mm
Korpusbreite 600mm
Sockelhöhe 100mm

* Quadro V6 full extension drawer runners with integrated Silent System (loading capacity 30kg)

* Auszugsführungen Quadro V6 mit Vol্লাuszug und integriertem Dämpfungssystem Silent System (Belastbarkeit 30kg)



Drawer system with bottom cutout, rear panel height 70mm
Nominal runners length 470mm
Drawer side height 70mm

Schubkastensystem mit Bodenausschnitt, Rückwandhöhe 70mm
Nennlänge der Führungen 470mm
Zargenhöhe 70mm



Pot-and-pan drawer system with bottom cutout and railing, rear panel height 144mm
Nominal runners length 470mm
Drawer side height 144mm

Frontauszug mit Bodenausschnitt und Reling, Rückwandhöhe 144mm
Nennlänge der Führungen 470mm
Zargenhöhe 144mm



Internal organization OrgaStore
Cabinet width 600, 800, 900mm
Can also be used for customised drawer widths
by shortening the crosswise railing

Innenorganisation OrgaStore
Korpusbreite 600, 800, 900mm
Durch Kürzen der Querreling auch für individuelle
Korpusbreiten einsetzbar



Internal organization OrgaTray 560
Cabinet width (nominal runners length), mm:
400 (260), 500 (420), 600 (420), 800 (470), 900 (470)
Plastic cutlery tray with dividing elements for organising drawers in any way
For drawer side height 70mm

Innenorganisation OrgaTray 560
Korpusbreite (Nennlänge der Führungen), mm:
400 (260), 500 (420), 600 (420), 800 (470), 900 (470)
Kunststoffbesteckeneinsatz mit Trennelementen für individuelle Facheinteilung
Für Zargenhöhe 70mm

ArciTech** ○ Color White Farbe Weiß

● Color Anthracite Farbe Anthrazit

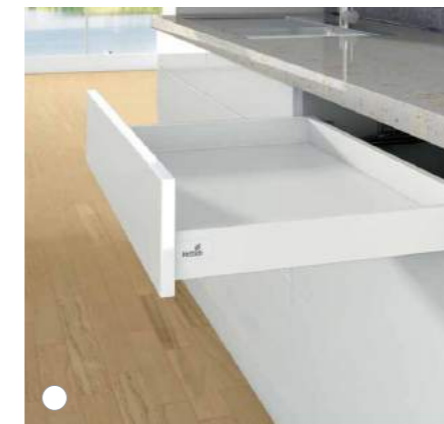

Drawer system, rear panel height 78mm
Nominal runners length 500mm
Drawer side height 78mm

Schubkastensystem, Rückwandhöhe 78mm
Nennlänge der Führungen 500mm
Zargenhöhe 78mm

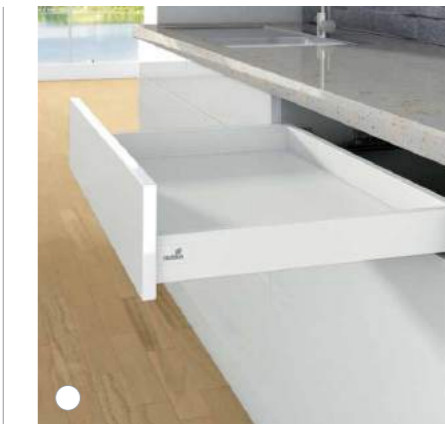

Drawer system, rear panel height 94mm
Nominal runners length 300, 500mm
Drawer side height 94mm

Schubkastensystem, Rückwandhöhe 94mm
Nennlänge der Führungen 300, 500mm
Zargenhöhe 94mm



Internal drawer system, rear panel height 94mm
Nominal runners length 300, 500mm
Drawer side height 94mm

Innenschubkastensystem, Rückwandhöhe 94mm
Nennlänge der Führungen 300, 500mm
Zargenhöhe 94mm



Pot-and-pan drawer system with railing, rear panel height 186mm
Nominal runners length 300, 500mm
Drawer side height 94mm

Frontauszug mit Reling, Rückwandhöhe 186mm
Nennlänge der Führungen 300, 500mm
Zargenhöhe 94mm

** Actro full extension drawer runners with integrated Silent System (loading capacity 40kg)

** Auszugsführungen Actro mit Vollauszug und integriertem Dämpfungssystem Silent System (Belastbarkeit 40kg)



Internal pot-and-pan drawer system with railing, rear panel height 186mm
Nominal runners length 300, 500mm
Drawer side height 94mm

Innenfrontauszug mit Reling, Rückwandhöhe 186mm
Nennlänge der Führungen 300, 500mm
Zargenhöhe 94mm



Pot-and-pan drawer system with double railing, rear panel height 250mm
Nominal runners length 300, 500mm
Drawer side height 94mm

Frontauszug mit Doppelreling, Rückwandhöhe 250mm
Nennlänge der Führungen 300, 500mm
Zargenhöhe 94mm



Drawer system with bottom cutout, rear panel height 94mm
Nominal runners length 500mm
Drawer side height 94mm

Schubkastensystem mit Bodenausschnitt, Rückwandhöhe 94mm
Nennlänge der Führungen 500mm
Zargenhöhe 94mm



Pot-and-pan drawer system with bottom cutout and railing, rear panel height 186mm
Nominal runners length 500mm
Drawer side height 94mm

Frontauszug mit Bodenausschnitt und Reling, Rückwandhöhe 186mm
Nennlänge der Führungen 500mm
Zargenhöhe 94mm



Pot-and-pan drawer system with DesignSide, rear panel height 186mm
Nominal runners length 300, 500mm
Drawer side height 94mm

Frontauszug mit DesignSide, Rückwandhöhe 186mm
Nennlänge der Führungen 300, 500mm
Zargenhöhe 94mm



Internal pot-and-pan drawer system with DesignSide, rear panel height 186mm
Nominal runners length 300, 500mm
Drawer side height 94mm

Innenfrontauszug mit DesignSide, Rückwandhöhe 186mm
Nennlänge der Führungen 300, 500mm
Zargenhöhe 94mm



Internal organization OrgaTray 570
Cabinet width (nominal runners length), mm: 450 (500), 600 (500), 900 (500)
Plastic cutlery tray with dividing elements for organizing drawers in any way
For drawer side height 94mm

Innenorganisation OrgaTray 570
Korpusbreite (Nennlänge der Führungen), mm: 450 (500), 600 (500), 900 (500)
Kunststoffbesteckensatz mit Trennelementen für individuelle Facheinteilung
Für Zargenhöhe 94mm

Catch for internal front panel Mitnehmer für Innenfront



Catch for internal front panel InnoTech Mitnehmer für Innenfront InnoTech



Set 1 catch for screwing on, 1 profile height increaser, fixing parts
 Material plastic
 Color grey

Set 1 Stück Mitnehmer zum Anschrauben, 1 Stück Profilerhöhung, Befestigungsmaterial
 Material Kunststoff
 Farbe grau

Catch for internal front panel ArciTech Mitnehmer für Innenfront ArciTech



Set 1 catch for screwing on, 1 profile height increaser, fixing parts
 Material plastic
 Color grey

Set 1 Stück Mitnehmer zum Anschrauben, 1 Stück Profilerhöhung, Befestigungsmaterial
 Material Kunststoff
 Farbe grau

Catch for internal front panel ArciTech Mitnehmer für Innenfront ArciTech



Set 1 catch for screwing on, 1 profile height increaser, fixing parts
 Material plastic
 Color anthracite

Set 1 Stück Mitnehmer zum Anschrauben, 1 Stück Profilerhöhung, Befestigungsmaterial
 Material Kunststoff
 Farbe Anthrazit

Quadro 25 drawer runners Auszugsführungen Quadro 25



Nominal length 250, 300, 350, 400, 450, 500mm Partial extension
 Integrated Silent System
 Loading capacity 25kg

Nennlänge 250, 300, 350, 400, 450, 500mm Teilauszug
 Integriertes Dämpfungssystem Silent System
 Belastbarkeit 25kg

Push to open Silent opening system for ArciTech
 Push to open Silent Öffnungssystem für ArciTech



Effortless easy opening, quiet and gentle closing
 Handleless opening (regular handles can be used)
 Suitable for 275-1200mm wide drawers
 Nominal runners length 300, 500mm
 Runners loading capacity 40, 60kg

Müheloses und leichtes Öffnen, stilles und sanftes Schließen
 Griffloses Öffnen (Standardgriffe möglich)
 Für 275-1200mm breite Schubkästen/Auszüge geeignet
 Nennlänge der Führungen 300, 500mm
 Belastbarkeit der Führungen 40, 60kg

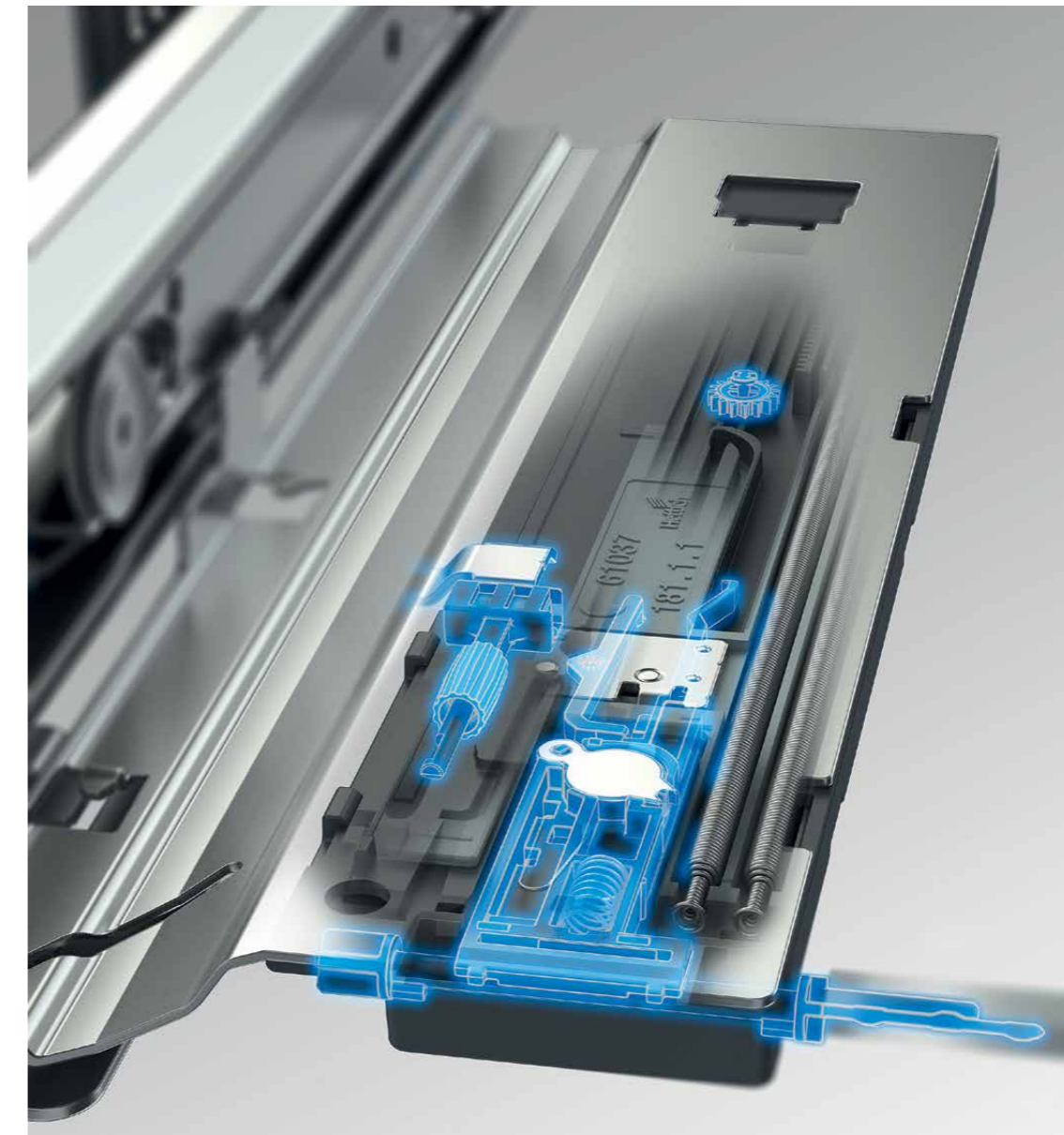

Equipped with smart synchronization, the system is also reliably activated in response to a press on the extremities of large front panels
 Maximum system performance 80kg

3 types of mechanisms are available:

- for drawers with total weight of 8-20kg (nominal runners length 270-650mm)
- for drawers with total weight of 10-40kg (nominal runners length 270-650mm)
- for drawers with total weight of 20-80kg (nominal runners length 400-650mm)

Mit Synchronisation ausgestattet, löst das System auch in den Randbereichen großer Schubkastenfronten zuverlässig aus
 Maximale Leistungsstärke des Systems 80kg

3 Typen von Mechanismen sind vorhanden:

- für Schubkästen mit Gesamtgewicht von 8-20kg (Nennlänge der Führungen 270-650mm)
- für Schubkästen mit Gesamtgewicht von 10-40kg (Nennlänge der Führungen 270-650mm)
- für Schubkästen mit Gesamtgewicht von 20-80kg (Nennlänge der Führungen 400-650mm)

UNISET METAL BOX Drawer systems UNISET METAL BOX Schubkastensysteme

Drawer system with railing Schubkastensystem mit Reling



Rear panel height 207mm
 Drawer side height 150mm
 Roller runners with partial extension
 Nominal runners length 500mm
 Integrated dampening SlowMotion as additional feature
 Can be provided without railing (in that case drawer side height will be equal to rear panel height)
 Drawer side in white color

Rückwandhöhe 207mm
 Zargenhöhe 150mm
 Rollenführungen mit Teilauszug
 Nennlänge der Führungen 500mm
 Integrierte Dämpfung SlowMotion (extra bestellbar)
 Kann ohne Reling geliefert werden (in diesem Fall werden die Zargenhöhe und Rückwandhöhe gleich sein)
 Zargenfarbe weiß



Drawer system without railing Schubkastensystem ohne Reling



Rear panel height 85mm
 Drawer side height 85mm
 Roller runners with partial extension
 Nominal runners length 500mm
 Integrated dampening SlowMotion as additional feature
 Drawer side in white color

Rückwandhöhe 85mm
 Zargenhöhe 85mm
 Rollenführungen mit Teilauszug
 Nennlänge der Führungen 500mm
 Integrierte Dämpfung SlowMotion (extra bestellbar)
 Zargenfarbe weiß

Under-oven drawer system Schubkastensystem für Herdunterbau



Rear panel height 53mm
 Drawer side height 53mm
 Roller runners with partial extension
 Nominal runners length 500mm
 Integrated dampening SlowMotion as additional feature
 Drawer side in white color

Rückwandhöhe 53mm
 Zargenhöhe 53mm
 Rollenführungen mit Teilauszug
 Nennlänge der Führungen 500mm
 Integrierte Dämpfung SlowMotion (extra bestellbar)
 Zargenfarbe weiß

PULL-OUT UNITS AND ACCESSORIES

AUSZÜGE UND ZUBEHÖR

VS SUB Slim Pull-out storage unit with two storage racks VS SUB Slim Etageauszug mit zwei Ablageelementen



Cabinet width 150mm
 Minimum cabinet depth 516mm
 Minimum cabinet height 566mm Integrated
 soft-closing
 Payload capacity up to 6kg per shelf element

Korpusbreite 150mm
 Korpushöhe min. 516mm
 Korpushöhe min. 566mm
 Integrierte Dämpfung
 Zuladung max. 6kg je Ablageelement

VS SUB Flex (BASE LINER) Pull-out unit for base cabinets VS SUB Flex (BASE LINER) für Unterschränke



Cabinet width 450, 500, 600mm
 Minimum cabinet depth 491mm
 Minimum cabinet height 691mm
 Height-adjustable storage elements at the second and third level
 Baskets in Saphir design
 Integrated soft-closing
 Payload capacity of the system up to 40kg

Korpusbreite 450, 500, 600mm
 Korpushöhe min. 491mm
 Korpushöhe min. 691mm
 Höhenverstellbare Ablageelemente in der zweiten und dritten Ebene Körbe in
 Saphir-Ausführung
 Integrierte Dämpfung
 Zuladung (System) max. 40kg

VS SUB Side (DSA) Side pull-out unit VS SUB Side (DSA) Seitenauszug



DSA с полотенцедержателем
DSA with towel holder
DSA mit Handtuchhalter

DSA-3

DSA-8

Cabinet width 150, 150 (DSA with towel holder),
200, 300, 400mm
Minimum cabinet depth 516mm
Height-adjustable baskets in Saphir design
Integrated soft-closing
Payload capacity of the system up to 20kg

Korpusbreite 150, 150 (DSA mit Ablageelementen zur
Aufbewahrung von Handtüchern und Backblechen),
200, 300, 400mm
Korpustiefe min. 516mm
Höhenverstellbare Körbe in Saphir-Ausführung
Integrierte Dämpfung
Zuladung (System) max. 20kg

	Cabinet width Korpusbreite (mm)	Minimum cabinet height Minimale Korpushöhe (mm)	Minimum cabinet depth Minimale Korpustiefe (mm)	Number of baskets Anzahl von Körben
DSA-3	150, 200, 300, 400	689	516	2
for tall units für Hochschränke	150, 200	1873	516	6

VS TAL Larder (HSA) Pull-out larder unit VS TAL Larder (HSA) Hochschrankauszug



HSA-5

Cabinet width 300, 450, 600mm
Minimum cabinet depth 519mm
Cabinet height 986-2176mm
Height-adjustable baskets in Saphir design
Integrated soft-closing
Payload capacity of the system up to 80kg

Korpusbreite 300, 450, 600mm
Korpustiefe min. 519mm
Korpushöhe 986-2176mm
Höhenverstellbare Körbe in Saphir-Ausführung
Integrierte Dämpfung
Zuladung (System) max. 80kg

	Cabinet width Korpusbreite (mm)	Cabinet height Korpushöhe (mm)	Minimum cabinet depth Minimale Korpustiefe (mm)	Number of baskets Anzahl von Körben
HSA-2	300, 450, 600	986-1236	519	3
HSA-3	300, 450, 600	1236-1486	519	4
HSA-5	300, 450	1736-1986	519	5
HSA-6	300	1936-2176	519	5

OSA Pull-out unit for wall cabinets OSA Auszug für Hängeschränke



L/R

Cabinet width 450, 600mm
Minimum cabinet depth 306mm
Minimum cabinet height 536mm
2 height-adjustable baskets in Saphir design Payload
capacity of the system up to 5kg

Korpusbreite 450, 600mm
Korpustiefe min. 306mm
Korpushöhe min. 536mm
2 höhenverstellbare Körbe in Saphir-Ausführung
Zuladung (System) max. 5kg

VS TAL Gate (VSA) Pull-out storage unit VS TAL Gate (VSA) Vorratsschrankauszug



L/R

Cabinet width 600mm
Minimum cabinet depth 496mm
Cabinet height 1736-1986mm
5 height-adjustable baskets in Saphir design Payload
capacity of the system up to 75kg

Korpusbreite 600mm
Korpustiefe min. 496mm
Korpushöhe 1736-1986mm
5 höhenverstellbare Körbe in Saphir-Ausführung
Zuladung (System) max. 75kg

VS COR Fold (WARI CORNER) for corner cabinets VS COR Fold (WARI CORNER) fr Eckschmke



L/R

Cabinet width 900, 1000mm
 Front width 450-600mm, 500-600mm
 Minimum cabinet depth 506mm
 Minimum cabinet height 571mm
 Height-adjustable shelf elements Saphir design
 Maximum payload capacity 8kg per front basket, 9,5kg per rear basket

Korpusbreite 900, 1000mm
 Frontbreite 450-600mm, 500-600mm
 Korpustiefe min. 506mm
 Korpushöhe min. 571mm
 Höhenverstellbare Körbe in Saphir-Ausführung
 Zuladung max. 8kg je Frontkorb, hintere Körbe jeweils 9,5kg

CORNERSTONE for corner cabinets CORNERSTONE fr Eckschmke



L/R

Cabinet width 900, 1000mm
 Door width 450mm, 500-600mm
 Minimum cabinet depth 506mm
 Minimum cabinet height 561mm
 Height-adjustable round shelves in Rail design
 Payload capacity up to 20kg per shelf

Korpusbreite 900, 1000mm
 Türbreite 450mm, 500-600mm
 Korpustiefe min. 506mm
 Korpushöhe min. 561mm
 Höhenverstellbare Rundböden in Rail-Ausführung
 Zuladung max. 20kg je Boden

TWIN CORNER for corner cabinets TWIN CORNER fr Eckschmke



Cabinet width 1000mm
 Minimum door width 600mm (L) Minimum cabinet depth 511mm Minimum cabinet height 541mm Maximum payload capacity 20kg per shelf Round shelves in Rail design

Korpusbreite 1000mm
 Türbreite min. 600mm (L)
 Korpustiefe min. 511mm
 Korpushöhe min. 541mm
 Zuladung max. 20kg je Boden Rundböden in Rail-Ausführung

VS TAL Gate Pro (DUSA) Выдвижная система VS TAL Gate Pro (DUSA) Pull-out storage unit VS TAL Gate Pro (DUSA) Hochschrankauszug



L/R

Cabinet width 450, 500, 600mm
 Minimum cabinet depth 516mm
 Cabinet height 686-2186mm
 Height-adjustable baskets in Saphir design
 Maximum payload capacity: 20kg/door (5kg per basket), 80kg/slide (20kg per basket)

Korpusbreite 450, 500, 600mm
 Korpustiefe min. 516mm
 Korpushöhe 686-2186mm
 Höhenverstellbare Körbe in Saphir-Ausführung
 Zuladung: Frontkörbe max. 20kg (5kg je Korb), Auszug max. 80kg (20kg je Korb)

	Cabinet width Korpusbreite (mm)	Cabinet height Korpushöhe (mm)	Minimum cabinet depth Minimale Korpustiefe (mm)	Number of baskets Anzahl von Körben
DUSA-1	450, 600	686-986	516	2+2
DUSA-2	450	986-1236	516	3+3
DUSA-3	450, 600	1236-1486	516	4+4
DUSA-5	450, 600	1736-1986	516	5+5
DUSA-6	450, 500, 600	1936-2176	516	5+5

DUSA-6

VS ADD T.O.M. Door organization system VS ADD T.O.M. Trordnungsmodul



L/R

Cabinet width 600mm
Minimum cabinet height 516mm System
depth 71mm

Korpusbreite 600mm
Korpushöhe min. 516mm
Tiefe (System) 71mm

VS COR Wheel Pro (RECORNER MAXX) for corner cabinets VS COR Wheel Pro (RECORNER MAXX) für Eckschränke



L/R

Cabinet width 600x600mm (wall unit), 900x900mm (base unit) Minimum
cabinet depth 306, 536mm
Minimum cabinet height 620mm
No central upright
Can be installed in base and wall units
Height-adjustable round shelves in Rail design
Maximum payload capacity: 27,5kg per shelf (base units),
12kg per shelf (wall units)
Shelf versions 3/4, 4/4

Korpusbreite 600x600mm (Hängeschrank), 900x900mm (Unterschrank)
Korpustiefe min. 306, 536mm
Korpushöhe min. 620mm
Kein mittiges Standrohr
Einsetzbar im Unterschrank und Hängeschrank
Höhenverstellbare Rundböden in Rail-Ausführung
Zuladung: max. 27,5kg pro Boden (Unterschrank),
12kg pro Boden (Hängeschrank)
Bodenausführungen 3/4, 4/4

RECORNER MAXX 3/4

RECORNER MAXX 4/4

Cabinet width Korpusbreite (mm)	Minimum cabinet height Minimale Korpushöhe (mm)	Minimum cabinet depth Minimale Korpustiefe (mm)	Diameter of shelves Durchmesser der Regale (mm)
600x600	620	306	480
900x900	620	536	760

VS SUB Sink Sink basket pull-out unit for base cabinet VS SUB Sink Splenkorbauszug für Unterschrank



Cabinet width 800, 900mm
Minimum cabinet depth 533mm
Minimum cabinet height 226mm
Integrated soft-closing
Payload capacity up to 20kg
Basket in Saphir design

Korpusbreite 800, 900mm
Korpustiefe min. 533mm
Korpushöhe min. 226mm
Integrierte Dämpfung
Zuladung max. 20kg
Korb in Saphir-Ausführung

VS TOP Spice Spice rack VS TOP Spice Gewürzregal



L/R

For standard 24 spice jars
Cabinet width 500mm
Minimum door width 496mm Minimum
cabinet height 540mm Height/width/
depth (system):
470/425/84mm

Für 24 handelsübliche Gewürzdosens
Korpusbreite 500mm
Türbreite min. 496mm
Korpushöhe min. 540mm
Höhe/Breite/Tiefe (System):
470/425/84mm

L/R

For standard 12 spice jars
Cabinet width 350mm
Minimum door width 326mm Minimum
cabinet height 540mm Height/width/
depth (system):
470/250/84mm

Für 12 handelsübliche Gewürzdosens
Korpusbreite 350mm
Türbreite min. 326mm
Korpushöhe min. 540mm
Höhe/Breite/Tiefe (System):
470/250/84mm

VS ADD Shelf Fixed storage rack VS ADD Shelf Feste Tablarablage



Cabinet width 600, 900mm
 Minimum cabinet depth 501mm
 Shelf depth 465mm
 Payload capacity up to 15kg per shelf element
 Rack in Saphir design

Korpusbreite 600, 900mm
 Korpusstärke min. 501mm
 Ablagetiefe 465mm
 Zuladung max. 15kg je Ablageelement
 Tablarablage in Saphir-Ausführung



Baskets and shelves in Saphir design
 Ablageelemente in Saphir-Ausführung



Round shelves in Rail design
 Rundböden in Rail-Ausführung

VS SUB Basket Pull-out basket for hinged door/with front mounting
 VS SUB Basket Korbauszug zum Einbau als Innen- oder Frontauszug



Pull-out basket for hinged door
 Innenauszug



Pull-out basket with front mounting
 Frontauszug

(L/R)

Cabinet width 450, 600, 900mm
 Minimum cabinet depth 531mm
 Minimum cabinet height 226mm (for one basket with front mounting) and 201mm (for one basket without front mounting)
 Spacing strip is mounted for baskets behind a hinged door
 Payload capacity up to 20kg per basket
 Baskets in Saphir design

Korpusbreite 450, 600, 900mm
 Korpusstärke min. 531mm
 Korpushöhe min. 226mm (für 1 Korb mit Frontanbindung) und 201mm (für 1 Korb ohne Frontanbindung)
 Distanzleiste zur Montage hinter der Tür
 Zuladung max. 20kg pro Korb
 Körbe in Saphir-Ausführung

VS ENVI Center (ÖKO CENTER) Waste bin system VS ENVI Center (ÖKO CENTER) Abfalltrennsystem



ÖKO CENTER 2



ÖKO CENTER 3

(L/R)

Minimum cabinet width 400mm (2 bins), 500mm (3 and 4 bins)
 Minimum cabinet depth 371mm (2 bins)
 Minimum cabinet depth 471mm (3 and 4 bins)
 Minimum installation height 566mm
 No additional stress load on the front
 Bins swing out automatically when opening the door

Korpusbreite min. 400mm (für Zweifach-Trennung), 500mm (für Drei- und Vierfach-Trennung)
 Korpusstärke min. 371mm (für Zweifach-Trennung)
 Korpusstärke min. 471mm (für Drei- und Vierfach-Trennung)
 Korpushöhe min. 566mm
 Keine zusätzliche Belastung der Front
 Automatisch ausschwenkende Behälter beim Öffnen der Tür



ÖKO CENTER 4

	Number of bins Anzahl der Eimer	Bin capacity (l) Volumen der Eimer (l)
ÖKO CENTER 2	2	9+9
ÖKO CENTER 3	3	9+12+18
ÖKO CENTER 4	4	9+9+9+12

VS ENVI Flex (ÖKO FLEXLINER) Система для сортировки отходов
VS ENVI Flex (ÖKO FLEXLINER) Waste bin system VS ENVI Flex (ÖKO FLEXLINER) Abfalltrennsystem



ÖKO FLEXLINER 2

ÖKO FLEXLINER 3

Cabinet width 450, 600mm
 Minimum cabinet height 450mm
 Minimum cabinet depth 519mm (for ArciTech drawer system),
 501mm (for InnoTech drawer system)
 Powder-coated removable lid for additional storage space
 Can be combined only with InnoTech (nominal runners length 470mm)
 and ArciTech (nominal runners length 500mm) drawer systems

Korpusbreite 450, 600mm
 Korpushöhe min. 450mm
 Korpustiefe min. 519mm (für Schubkastensystem ArciTech),
 501mm (für Schubkastensystem InnoTech)
 Zusätzliche Ablage durch pulverbeschichtetes, ausziehbares Abdeckblech
 Kombinierbar nur mit Schubkastensystem InnoTech
 (Nennlänge der Führungen 470mm) und ArciTech
 (Nennlänge der Führungen 500mm)

	Cabinet width Korpusbreite (mm)	Number of bins Anzahl der Eimer	Bin capacity (l) Volumen der Eimer (l)
ÖKO FLEXLINER 2	450	2	10+10
ÖKO FLEXLINER 3	600	3	10+10+22

VS ENVI Space (ÖKO LINER) Waste bin system VS ENVI Space (ÖKO LINER) Abfalltrennsystem



ÖKO LINER 2

ÖKO LINER 3

Cabinet width 450, 600mm
 Minimum cabinet depth 480mm
 Minimum cabinet height 450mm
 System height 370mm
 Soft close full extension runners
 Powder-coated removable lid for additional storage space

Korpusbreite 450, 600mm
 Korpustiefe min. 480mm
 Korpushöhe min. 450mm
 Höhe (System) 370mm
 Führungen mit Vollauszug und integrierter Dämpfung
 Zusätzliche Ablage durch pulverbeschichtetes, ausziehbares Abdeckblech

	Cabinet width Korpusbreite (mm)	Number of bins Anzahl der Eimer	Bin capacity (l) Volumen der Eimer (l)
ÖKO LINER 2	450	2	16+16
ÖKO LINER 3	600	3	10+10+22

CHROME Pull-out unit
CHROM Auszug



Cabinet width 150, 200, 300, 400mm
 Minimum cabinet depth 511mm (for cabinet widths 150, 200mm)
 Minimum cabinet depth 481mm (for cabinet widths 300, 400mm)
 Minimum cabinet height 586mm (for cabinet widths 150, 200mm)
 Minimum cabinet height 576mm (for cabinet widths 300, 400mm)
 Baskets with front mounting
 Soft close runners with partial extension
 Payload capacity of the system up to 25kg

Korpusbreite 150, 200, 300, 400mm
 Korpustiefe min. 511mm (für Korpusbreiten 150, 200mm)
 Korpustiefe min. 481mm (für Korpusbreiten 300, 400mm)
 Korpushöhe min. 586mm (für Korpusbreiten 150, 200mm)
 Korpushöhe min. 576mm (für Korpusbreiten 300, 400mm)
 Körbe mit Frontanbindung
 Führungen mit Teilauszug und integrierter Dämpfung
 Zuladung (System) max. 25kg

CHROME Pull-out unit for corner cabinets CHROM Auszug für Eckschmke



L/R

Minimum installation (actual) cabinet width 1000 (960)mm
 Minimum front width 450mm
 Minimum cabinet depth 511mm
 Minimum cabinet height 571mm
 Baskets with front mounting
 Payload capacity of the system up to 25kg

Einbau- (tatsächliche) Korpusbreite 1000 (960)mm
 Frontbreite min. 450mm
 Korpustiefe min. 511mm
 Korpushöhe min. 571mm
 Körbe mit Frontanbindung
 Zuladung (System) max. 25kg

MIDI / MAXI Pull-out unit for tall cabinets MIDI / MAXI Auszug für Hochschmke



MIDI

Cabinet width 300mm
 Minimum cabinet depth 510mm
 Cabinet height 1346-1746mm
 4 height-adjustable baskets with front mounting
 Integrated soft-closing
 Payload capacity of the system up to 25kg

Korpusbreite 300mm
 Korpus-tiefe min. 510mm
 Korpus-höhe 1346-1746mm
 4 höhenverstellbare Körbe mit Frontanbindung
 Integrierte Dämpfung
 Zuladung (System) max. 25kg

MAXI

Cabinet width 400mm
 Minimum cabinet depth 510mm
 Cabinet height 1946-2346mm
 6 height-adjustable baskets with front mounting
 Integrated soft-closing
 Payload capacity of the system up to 25kg

Korpusbreite 400mm
 Korpus-tiefe min. 510mm
 Korpus-höhe 1946-2346mm
 6 höhenverstellbare Körbe mit Frontanbindung
 Integrierte Dämpfung
 Zuladung (System) max. 25kg

CHROME 45 Pull-out unit CHROM 45 Auszug



Cabinet width 450mm
 Minimum cabinet depth 511mm
 Minimum cabinet height 560mm
 2 baskets with front mounting
 Integrated soft-closing
 Payload capacity of the system up to 25kg

Korpusbreite 450mm
 Korpus-tiefe min. 511mm
 Korpus-höhe min. 560mm
 2 Körbe mit Frontanbindung
 Integrierte Dämpfung
 Zuladung (System) max. 25kg

CHROME 50 Pull-out unit CHROM 50 Auszug



Cabinet width 500mm
 Minimum cabinet depth 476mm
 Minimum cabinet height 576mm
 2 baskets with front mounting
 Integrated soft-closing
 Payload capacity of the system up to 25kg

Korpusbreite 500mm
 Korpus-tiefe min. 476mm
 Korpus-höhe min. 576mm
 2 Körbe mit Frontanbindung
 Integrierte Dämpfung
 Zuladung (System) max. 25kg

Pull-out draining rack Ausziehbares Abtropfgestell



Cabinet width 600, 800, 900mm
 Minimum cabinet depth 476mm
 Minimum cabinet (front) height 245mm
 Quadro 25 runners with partial extension
 and integrated Silent System
 Suitable for drawers

Korpusbreite 600, 800, 900mm
 Korpus-tiefe min. 476mm
 Korpus- bzw. Fronthöhe min. 245mm
 Führungen Quadro 25 mit Teilauszug und integriertem
 Dämpfungssystem Silent System
 Für Auszüge geeignet

HINGES SCHARNIERE

Intermat concealed hinges without integrated Silent System
Intermat Topfscharniere ohne integriertes Dämpfungssystem Silent System



Standard hinge full overlay / half overlay / inset
(opening angle 110°, for 90° construction)

Standardscharnier voll vorliegend / halb vorliegend / einliegend
(Öffnungswinkel 110°, für 90°-Konstruktion)

Standard hinge full overlay / half overlay (opening angle 110°, for 90° construction)
Unsprung, for Push to open Magnet

Standardscharnier voll vorliegend / halb vorliegend
(Öffnungswinkel 110°, für 90°-Konstruktion)
Ungefedert, für Push to open Magnet



Full overlay wide-angle hinge
(opening angle 165°, for 90° construction)

Weitwinkelscharnier voll vorliegend
(Öffnungswinkel 165°, für 90°-Konstruktion)



W20 full overlay angle hinge (opening angle 95°, for 20° face angle)

W20 Winkelscharnier voll vorliegend (Öffnungswinkel 95°, für Korpuswinkel 20°)



W45 full overlay angle hinge (opening angle 95°, for 45° face angle)
W45 Winkelscharnier voll vorliegend (Öffnungswinkel 95°, für Korpuswinkel 45°)



W-30 full overlay negative angle hinge (opening angle 125°, for -30° face angle)
W-30 Negativ-Winkelscharnier voll vorliegend (Öffnungswinkel 125°, für Korpuswinkel -30°)



W-45 full overlay negative angle hinge (opening angle 125°, for -45° face angle)
W-45 Negativ-Winkelscharnier voll vorliegend (Öffnungswinkel 125°, für Korpuswinkel -45°)



Folding door full overlay hinge (corner cabinet construction)
Falttürscharnier voll vorliegend (Eckschrank-Konstruktion)



W90 blind corner inset hinge (opening angle 95°, for 90° face angle)
W90 Stollenscharnier einliegend (Öffnungswinkel 95°, für Korpuswinkel 90°)

Sensys concealed hinges with integrated Silent System
Sensys Topfscharniere mit integriertem Dämpfungssystem Silent System



Standard hinge full overlay / half overlay / inset
(opening angle 110°, for 90° construction)

Standardscharnier voll vorliegend / halb vorliegend / einliegend
(Öffnungswinkel 110°, für 90°-Konstruktion)

W30 full overlay angle hinge (opening angle 95°, for 30° face angle)

W30 Winkelscharnier voll vorliegend (Öffnungswinkel 95°, für Korpuswinkel 30°)



W45 full overlay angle hinge (opening angle 95°, for 45° face angle)

W45 Winkelscharnier voll vorliegend (Öffnungswinkel 95°, für Korpuswinkel 45°)



Full overlay wide-angle hinge in Internat Design
(opening angle 165°, for 90° construction)

Weitwinkelscharnier voll vorliegend im Internat-Design
(Öffnungswinkel 165°, für 90°-Konstruktion)



Folding door full overlay hinge without Silent System (corner cabinet construction)

Falttürscharnier voll vorliegend ohne Dämpfungssystem Silent System (Eckschrank-Konstruktion)



W90 blind corner inset hinge (opening angle 95°, for 90° face angle)

W90 Stollenscharnier einliegend (Öffnungswinkel 95°, für Korpuswinkel 90°)



Full overlay hinge for thick doors
(opening angle 95°, for 90° construction)
To be mounted together with decorative hinges
WCR250-H4, WCR250-E8, WCR250-D1, WCR250-T2

Dicktürscharnier voll vorliegend
(Öffnungswinkel 95°, für 90°-Konstruktion)
Zusammen mit Dekorscharnieren
WCR250-H4, WCR250-E8, WCR250-D1, WCR250-T2 montierbar

CLIP top BLUMOTION



Blind corner overlay hinge with integrated BLUMOTION
(opening angle 95°, for 90° face angle)

Aufschlagendes Stollenscharnier mit integrierter BLUMOTION
(Öffnungswinkel 95°, für Korpuswinkel 90°)

PUSH TO OPEN MAGNET Opening system for handleless hinged doors
PUSH TO OPEN MAGNET Öffnungssystem für grifflose Flügeltüren



White Weiß



Grey Grau



Anthracite Anthrazit

To be used with hinges without self closing feature
If hinges with self closing feature are used, a counter-plate is not installed
Magnetic stay close function
Opening movement 3,7mm
Large adjustment range of 6 mm

Die Anwendung mit Scharnieren ohne Schließautomatik
Wenn Scharniere ohne Schließautomatik gebraucht werden, wird keine Gegenplatte montiert
Magnetische Zuhaltung
Auslösehub 3,7mm
Großzügiger Verstellbereich von 6 mm

WingLine L Folding door system
WingLine L Falttürsystem

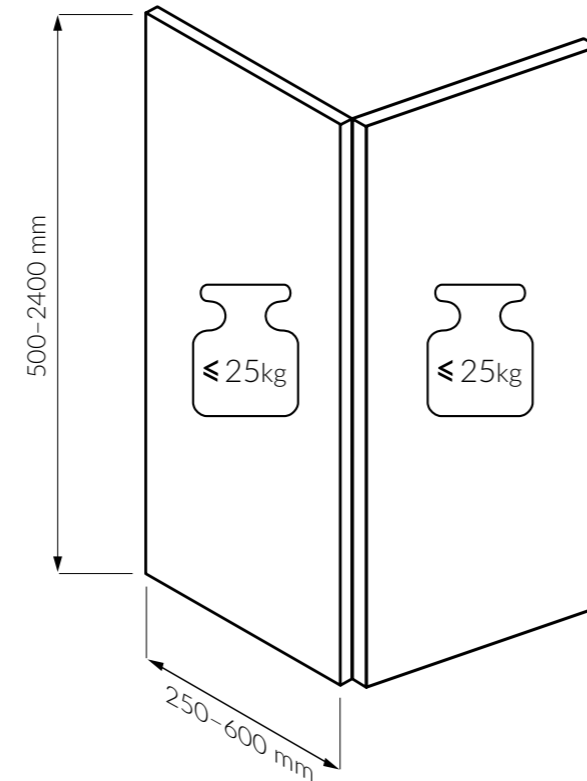

The revolutionary Push / Pull to move (Silent) opening mechanism
Optimized running performance
Soft opening and closing
Toolless installation
Minimal door protrusion for efficiently organizing the space inside
An impressive panorama effect

Die revolutionäre Öffnungsmechanik Push / Pull to move (Silent)
Die optimierte Laufperformance
Öffnungs- und Schließdämpfung
Werkzeuglose Montage
Minimaler Türeinsprung für eine raumeffiziente Innenorganisation
Ein beeindruckender Panoramaeffekt

Cabinet width for one folding door with two wings from 510 up to 1200mm
Door height from 500 up to 2400mm
Door wing weight up to 25kg
Door wing thickness from 16 up to 25mm

Schrankbreite für eine Falttür mit zwei Flügeln von 510 bis 1200mm Türhöhe von 500 bis 2400mm
Türflügelgewicht bis 25kg
Türflügelstärke von 16 bis 25mm

Opening mechanisms for WingLine L
Öffnungsmechanismen für WingLine L

Push to move	Pull to move	Pull to move Silent	Without opening support Ohne Öffnungsunterstützung
The door opens automatically in response to a light press on the front and is returned to the closed position by hand Durch leichten Druck auf die Front öffnet die Tür selbstständig und wird manuell wieder in die geschlossene Position geführt	The door opens automatically from a 1° opening angle in response to a minimal pull on the handle and is returned to the closed position by hand Durch minimalen Zug am Griff öffnet die Tür selbstständig ab 1° Öffnungswinkel und wird manuell wieder in die geschlossene Position geführt	The door opens automatically from a 35° opening angle in response to a slight pull on the handle and is returned to the closed position in a cushioned movement Durch leichten Zug am Griff öffnet die Tür selbstständig ab 35° Öffnungswinkel und fährt gedämpft zurück in die geschlossene Position	The door opens and is returned to the closed position by hand Die Tür öffnet und wird in die geschlossene Position manuell geführt



LIFT SYSTEMS KLAPPENSYSTEME

Opening support systems Öffnungsunterstützung



SERVO-DRIVE Electrical motion support system
(for AVENTOS HF, HL, HS)

SERVO-DRIVE Elektrische Bewegungsunterstützung
(für AVENTOS HF, HL, HS)

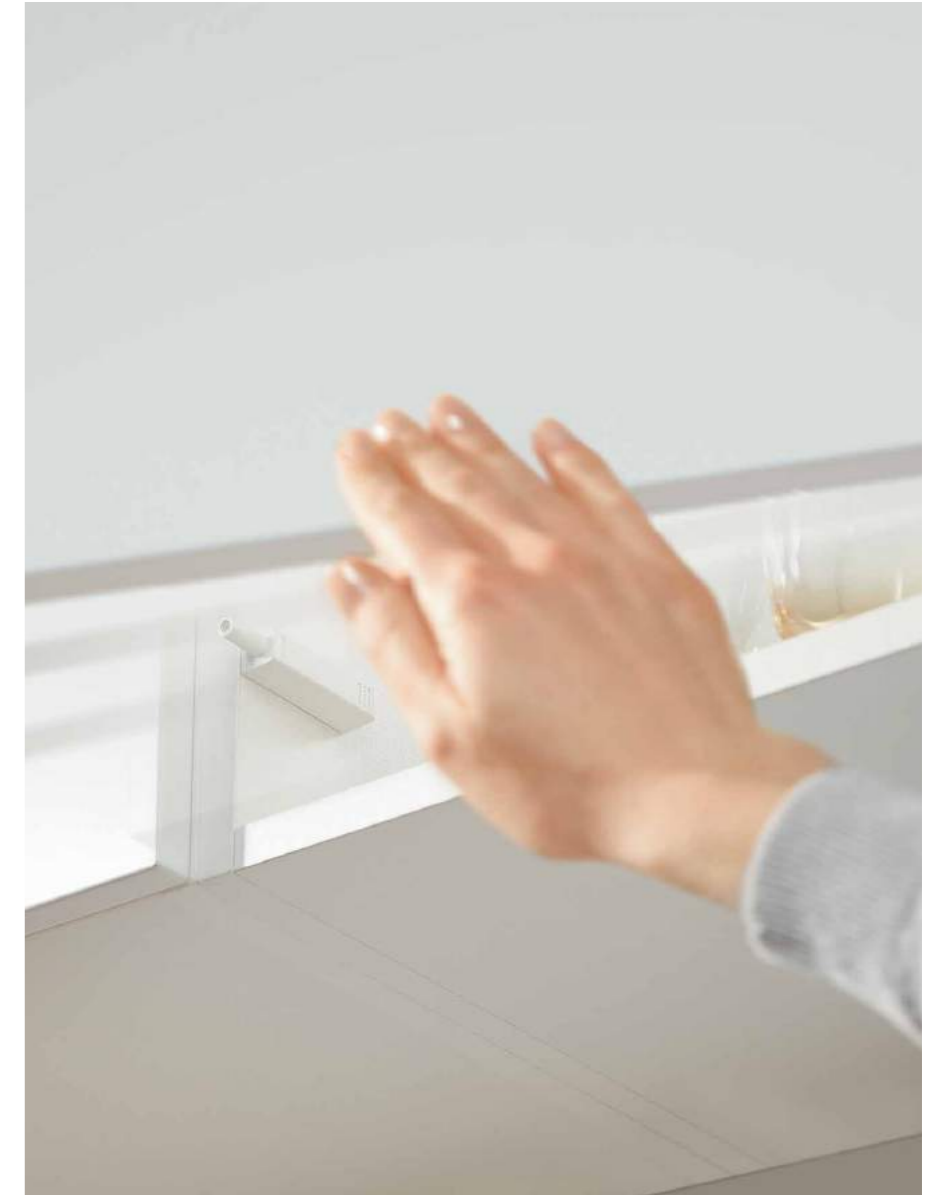

TIP-ON Mechanical opening support system
(for AVENTOS HK, HK top, HK-S, HK-XS, hinged doors)

TIP-ON Mechanische Öffnungsunterstützung
(für AVENTOS HK, HK top, HK-S, HK-XS, Flügeltüren)

AVENTOS HF Bi-fold lift system AVENTOS HF Hochfaltklappe



3 types of lift mechanisms are available:
20F2200 (LF 960-5500), **20F2500** (LF 5350-10150), **20F2800** (LF 9000-17250)
 Using the power factor you can determine required lift mechanism.

i Power factor LF =
 cabinet height KH (mm) x lower and upper front weight incl. handle (kg)

1 telescopic arm set is available: **20F3800** for cabinet height 700-915mm
 Cabinet width up to 1800mm
 Cabinet height from 700mm to 915mm
 Can be combined with SERVO-DRIVE
 Integrated BLUMOTION

3 Typen von Kraftspeichern sind vorhanden:
20F2200 (LF 960-5500), **20F2500** (LF 5350-10150), **20F2800** (LF 9000-17250)
 Mit Hilfe des Leistungsfaktors können Sie den benötigten Kraftspeicher bestimmen.

i Leistungsfaktor LF =
 Korpshöhe KH (mm) x Frontgewicht (untere und obere Front) inkl. Griff (kg)

1 Teleskophebel-Set ist vorhanden: **20F3800** für Korpshöhe 700-915mm
 Korpusbreite bis 1800mm
 Korpshöhe ab 700mm bis 915mm
 Kombinierbar mit SERVO-DRIVE
 Integrierte BLUMOTION

AVENTOS HK Stay lift system AVENTOS HK Hochklappe



3 types of lift mechanisms are available:
20K2500 (LF 750-2500), **20K2700** (LF 1500-4900), **20K2900** (LF 3200-9000)
 Using the power factor you can determine required lift mechanism.

i Power factor LF =
 cabinet height KH (mm) x front weight incl. double handle weight (kg)

Cabinet width up to 1800mm
 Cabinet height up to 600mm
 Integrated BLUMOTION
 Can be combined with TIP-ON (without BLUMOTION dampening)

3 Typen von Kraftspeichern sind vorhanden:
20K2500 (LF 750-2500), **20K2700** (LF 1500-4900), **20K2900** (LF 3200-9000)
 Mit Hilfe des Leistungsfaktors können Sie den benötigten Kraftspeicher bestimmen.

i Leistungsfaktor LF =
 Korpshöhe KH (mm) x Frontgewicht inkl. doppeltes Griffgewicht (kg)

Korpusbreite bis 1800mm
 Korpshöhe bis 600mm
 Integrierte BLUMOTION
 Kombinierbar mit TIP-ON (keine BLUMOTION-Dämpfung)

AVENTOS HK top Stay lift system AVENTOS HK top Hochklappe



3 types of lift mechanisms are available:
22K2511 (LF 930-2800), **22K2711** (LF 1730-5200), **22K2911** (LF 3200-9000)
 Using the power factor you can determine required lift mechanism.

i Power factor LF =
 cabinet height KH (mm) x front weight incl. double handle weight (kg)

Cabinet width up to 1800mm
 Cabinet height up to 600mm
 Integrated BLUMOTION
 Can be combined with TIP-ON (without BLUMOTION dampening)

3 Typen von Kraftspeichern sind vorhanden:
22K2511 (LF 930-2800), **22K2711** (LF 1730-5200), **22K2911** (LF 3200-9000)
 Mit Hilfe des Leistungsfaktors können Sie den benötigten Kraftspeicher bestimmen.

i Leistungsfaktor LF =
 Korpshöhe KH (mm) x Frontgewicht inkl. doppeltes Griffgewicht (kg)

Korpusbreite bis 1800mm
 Korpshöhe bis 600mm
 Integrierte BLUMOTION
 Kombinierbar mit TIP-ON (keine BLUMOTION-Dämpfung)



Aventos HK top



Aventos HK

AVENTOS HK top. Advantages AVENTOS HK top. Vorteile

Small dimensions Geringe Baugröße
 New clean-cut design Neues geradliniges Design
 Close to the top panel installation Montage nah am Korpusoberboden
 Extremely smooth motion Außergewöhnlich gleichmäßige Bewegung
 Comfortable lift mechanism adjustment from the front Komfortable Einstellung des Kraftspeichers von vorne
 Opening angle stop with infinitely variable adjustment Integrierter Öffnungswinkelbegrenzer mit stufenloser Anpassung

AVENTOS HS Up & over lift system AVENTOS HS Hochschwenklappe



6 types of lift mechanisms are available:
20S2A00 for cabinet height 350-525mm, **20S2B00** for cabinet height 350-525mm, **20S2D00** for cabinet height 526-675mm, **20S2E00** for cabinet height 526-675mm, **20S2F00** for cabinet height 526-675mm, **20S2G00** for cabinet height 676-800mm, **20S2H00** for cabinet height 676-800mm, **20S2I00** for cabinet height 676-800mm.

The cabinet height and door weight incl. handle are required in order to select the correct lift mechanism
 Cabinet width up to 1800mm
 Cabinet height from 350mm to 800mm
 Can be combined with SERVO-DRIVE
 Integrated BLUMOTION

3 Typen von Kraftspeichern sind vorhanden:
20S2A00 für Korpshöhe 350-525mm, **20S2B00** für Korpshöhe 350-525mm, **20S2D00** für Korpshöhe 526-675mm, **20S2E00** für Korpshöhe 526-675mm, **20S2F00** für Korpshöhe 526-675mm, **20S2G00** für Korpshöhe 676-800mm, **20S2H00** für Korpshöhe 676-800mm, **20S2I00** für Korpshöhe 676-800mm.

Zur Auswahl des richtigen Kraftspeichers benötigen Sie die Korpshöhe und das Gewicht der Front inkl. Griff
 Korpusbreite bis 1800mm
 Korpshöhe ab 350mm bis 800mm
 Kombinierbar mit SERVO-DRIVE
 Integrierte BLUMOTION

AVENTOS HL Lift up system AVENTOS HL Hochliftklappe

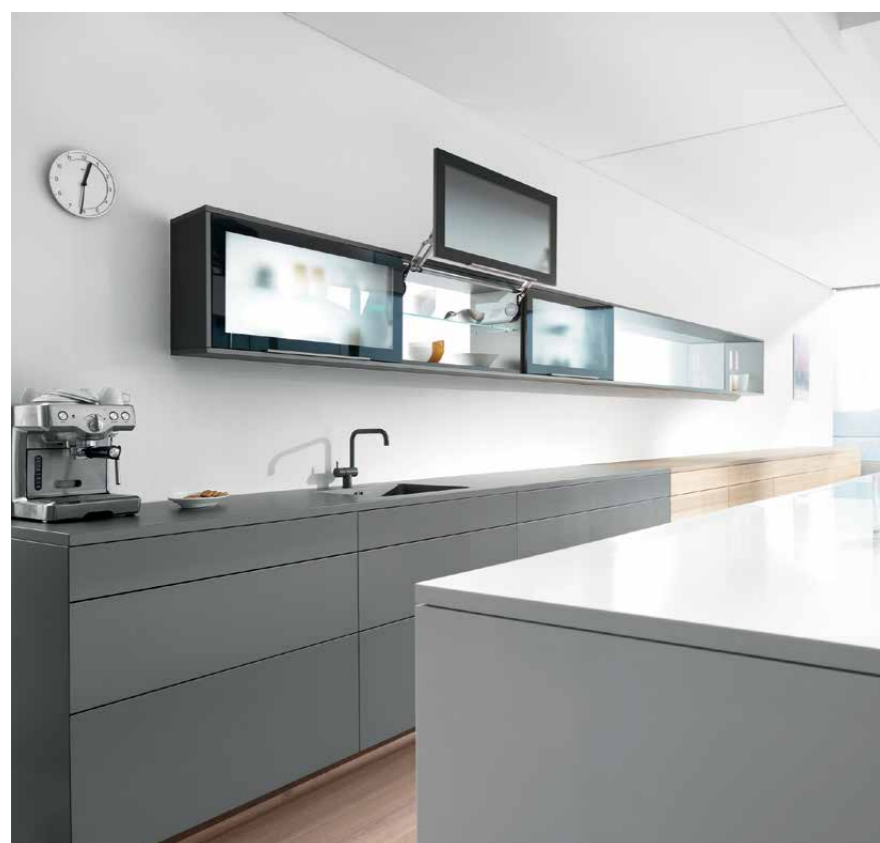

4 types of lift mechanisms are available: **20L2300**, **20L2500**, **20L2700**, **20L2900**
 3 lever arm sets are available:

20L3500 for cabinet height 350-399mm
20L3800 for cabinet height 400-550mm
20L3900 for cabinet height 450-580mm

The cabinet height and door weight incl. handle are required in order to select the correct lift mechanism
 Cabinet width up to 1800mm
 Cabinet height from 350mm to 580mm
 Can be combined with SERVO-DRIVE
 Integrated BLUMOTION

4 Typen von Kraftspeichern sind vorhanden: **20L2300**, **20L2500**, **20L2700**, **20L2900**
 3 Hebel-Sets sind vorhanden:

20L3500 für Korpshöhe 350-399mm
20L3800 für Korpshöhe 400-550mm
20L3900 für Korpshöhe 450-580mm

Zur Auswahl des richtigen Kraftspeichers benötigen Sie die Korpshöhe und das Gewicht der Front inkl. Griff
 Korpusbreite bis 1800mm
 Korpshöhe ab 350mm bis 580mm
 Kombinierbar mit SERVO-DRIVE
 Integrierte BLUMOTION

AVENTOS HK-S Small stay lift system AVENTOS HK-S Kleine Hochklappe



The **20K2E00 (LF 960-2215)** lift mechanism is available
 Using the power factor you can determine required lift mechanism.

i Power factor LF =
 cabinet height KH (mm) x front weight incl. double handle weight (kg)

Cabinet width depends on the power factor
 Cabinet height up to 600mm
 Integrated BLUMOTION
 Can be combined with TIP-ON (without BLUMOTION dampening)

Der Kraftspeicher **20K2E00 (LF 960-2215)** ist vorhanden
 Mit Hilfe des Leistungsfaktors können Sie den benötigten Kraftspeicher bestimmen.

i Leistungsfaktor LF =
 Korpshöhe KH (mm) x Frontgewicht inkl. doppeltes Griffgewicht (kg)

Korpusbreite hängt vom Leistungsfaktor ab
 Korpshöhe bis 600mm
 Integrierte BLUMOTION
 Kombinierbar mit TIP-ON (keine BLUMOTION-Dämpfung)

AVENTOS HK-XS Малый поворотный подъемник
AVENTOS HK-XS Small stay lift system AVENTOS HK-XS Kleine Hochklappe

The **20K1501 (LF 800-1800)** lift mechanism is available
 Using the power factor you can determine required lift mechanism.

i Power factor LF =
 cabinet height KH (mm) x front weight incl. double handle weight (kg)

Cabinet depth min.125mm
 Cabinet height from 240mm to 600mm
 Can be combined with TIP-ON (without BLUMOTION dampening)

Der Kraftspeicher **20K1501 (LF 800-1800)** ist vorhanden
 Mit Hilfe des Leistungsfaktors können Sie den benötigten Kraftspeicher bestimmen.

i Leistungsfaktor LF =
 Korpshöhe KH (mm) x Frontgewicht inkl. doppeltes Griffgewicht (kg)

Korpstiefe min.125mm
 Korpshöhe ab 240mm bis 600mm
 Kombinierbar mit TIP-ON (keine BLUMOTION-Dämpfung)

ILLUMINATION

BELEUCHTUNG

LED downlight LUMINO round
1,5W
(Ø 60mm)
LED downlight LUMINO rund 1,5W
(Ø 60mm)



Power unit for connecting up to 6 LED downlights
Color temperature 4000K
Light source color neutral white
Dimming dimmable
Housing material plastic
Number of LEDs 16
By default push switch for manual on/off switching provided

Netzteil für den Anschluss von bis zu 6 LED
downlights
Farbtemperatur 4000K
Farbe der Lichtquelle neutralweiß
Dimmen dimmbar
Gehäusematerial Kunststoff
Anzahl der LEDs 16
*Standardmäßig mit Druckschalter für manuelles Ein-
und Ausschalten versehen*

LED downlight ESTELLA square 1,2W
(53x53mm)
LED downlight ESTELLA quadratisch 1,2W
(53x53mm)



The following sensor switches are available:

- touch sensor switch with integrated dimming function
- 2 in 1 (door contact switch: door open = light on, door closed = light off; motion sensor) with integrated dimming function
- sensor switch for touch-free on/off switching (sensor range 40mm)

Die folgenden Sensorschalter sind verfügbar:

- Berührungssensor mit integrierter Dimmfunktion
- 2 in 1 (Türkontaktschalter: Tür auf = Licht an, Tür zu = Licht aus; Bewegungssensor) mit integrierter Dimmfunktion
- Sensorschalter zum berührungslosen Ein- und Ausschalten (Erfassungsbereich 40mm)

LED downlight BARRI round
1,5W
(Ø 69mm)
LED downlight BARRI rund 1,5W
(Ø 69mm)



Set 3 downlights
Color temperature 6400K
Light source color cool white
Housing material stainless steel / plastic
Number of LEDs 27

Set 3 Downlights
Farbtemperatur 6400K
Farbe der Lichtquelle kaltweiß
Gehäusematerial rostfreier Edelstahl / Kunststoff
Anzahl der LEDs 27

Illuminated LED glass shelf
LED Glasbodenleuchte



Functional illumination of wall unit interior and work surface

Touch sensor

Cabinet width 450, 600, 900mm

Cabinet depth 350mm

Material aluminum/frosted glass

Funktionale Ausleuchtung des Schrankinneren sowie auch der Arbeitsfläche

Berührungssensor

Korpusbreite 450, 600, 900mm

Korpus Tiefe 350mm

Material Aluminium/Milchglas

12V DC

2K LED glass edge lighting clip
2K LED-Clip für Glaskantenbeleuchtung

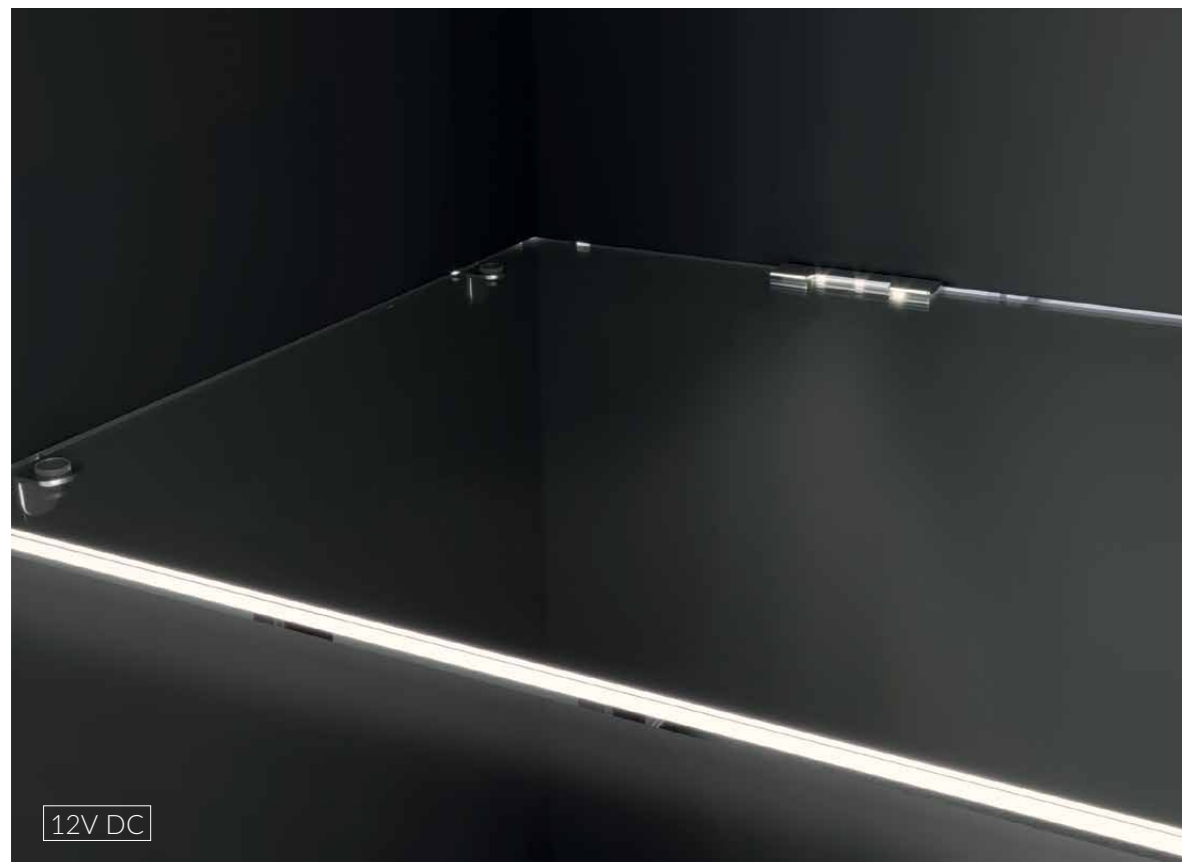

Shelf thickness 4-8mm

Power 0,25W

Color temperature 6200K

Light source color cool white

Material stainless steel

Number of LEDs 3

Glasstärke 4-8mm

Leistung 0,25W

Farbtemperatur 6200K

Farbe der Lichtquelle kaltweiß

Material rostfreier Edelstahl

Anzahl der LEDs 3

12V DC

Corner profile HLT with LED lighting
Eckprofil HLT mit LED Beleuchtung



Convenient illumination inside the drawer

Automatic magnetic sensor

Cabinet width 450, 600, 900mm

Material aluminum/plastic

Komfortable Ausleuchtung des Auszuginnenraums

Automatischer Magnetsensor

Korpusbreite 450, 600, 900mm

Material Aluminium/Kunststoff

12V DC

LED light strip
LED-Lichtleiste



Length 300mm

Power 2,2W

Color temperature 6400K

Light source color cool white

Material plastic

Number of LEDs 27

Länge 300mm

Leistung 2,2W

Farbtemperatur 6400K

Farbe der Lichtquelle kaltweiß

Material Kunststoff

Anzahl der LEDs 27

12V DC

Recessed LED profile
LED-Einbauprofil



Maximum length 3000mm
Material aluminum
Cover frosted plastic
End caps (optional) ABS silver

Maximale Länge 3000mm
Material Aluminium
Abdeckung Kunststoff satiniert
Endkappen (optional) ABS Silber

Surface mounted LED profile
LED-Aufbauprofil



Maximum length 3000mm
Material aluminum
Cover frosted plastic
End caps (optional) ABS silver

Maximale Länge 3000mm
Material Aluminium
Abdeckung Kunststoff satiniert
Endkappen (optional) ABS Silber

LED strip
(must be ordered separately for LED profiles)
Length 5000mm
Power 6W/meter
Supply voltage 12V DC
Color temperature 5000K
Light source color neutral white

LED-Streife
(für LED-Profil separat bestellbar)
Länge 5000mm
Leistung 6W/Meter
Betriebsspannung 12V DC
Farbtemperatur 5000K
Farbe der Lichtquelle neutralweiß

Edge LED profile (single-sided)
LED-Kantenprofil (einseitig)

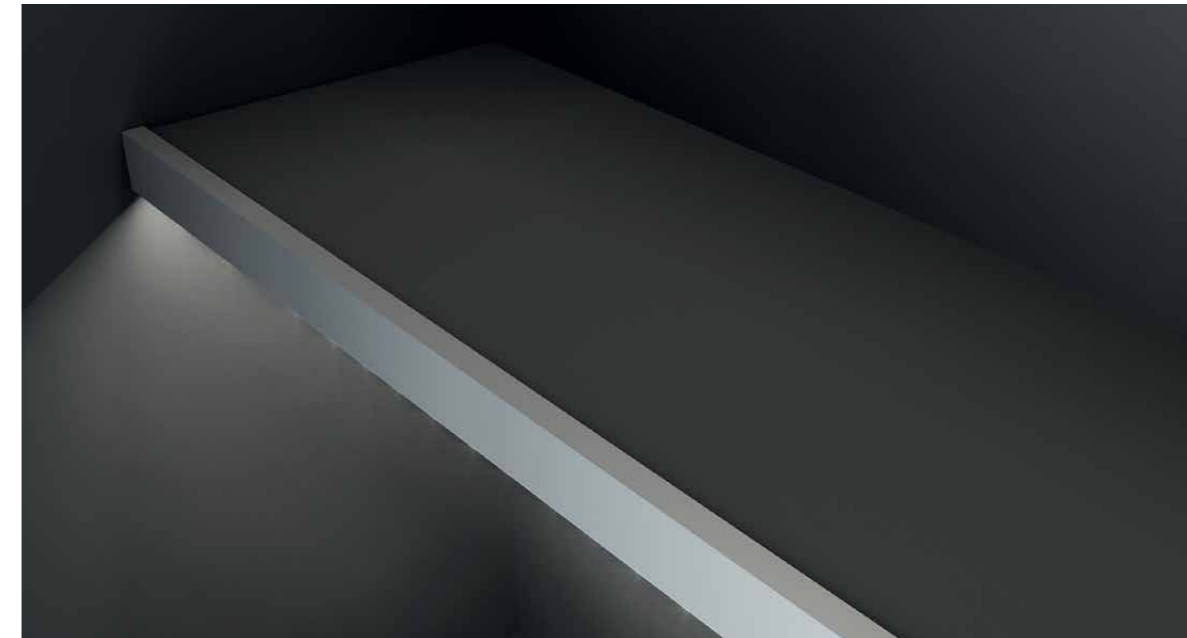

Shelf thickness 18mm
Maximum length 3000mm
Material aluminum
Cover frosted plastic

Einlegebodenstärke 18mm
Maximale Länge 3000mm
Material Aluminium
Abdeckung Kunststoff satiniert

Edge LED profile (double-sided)
LED-Kantenprofil (beidseitig)



Shelf thickness 18mm
Maximum length 3000mm
Material aluminum
Cover frosted plastic

Einlegebodenstärke 18mm
Maximale Länge 3000mm
Material Aluminium
Abdeckung Kunststoff satiniert

ACCESSORIES

ZUBEHÖR

SmartFrame

SmartFrame Shelving frame SmartFrame Regalrahmen

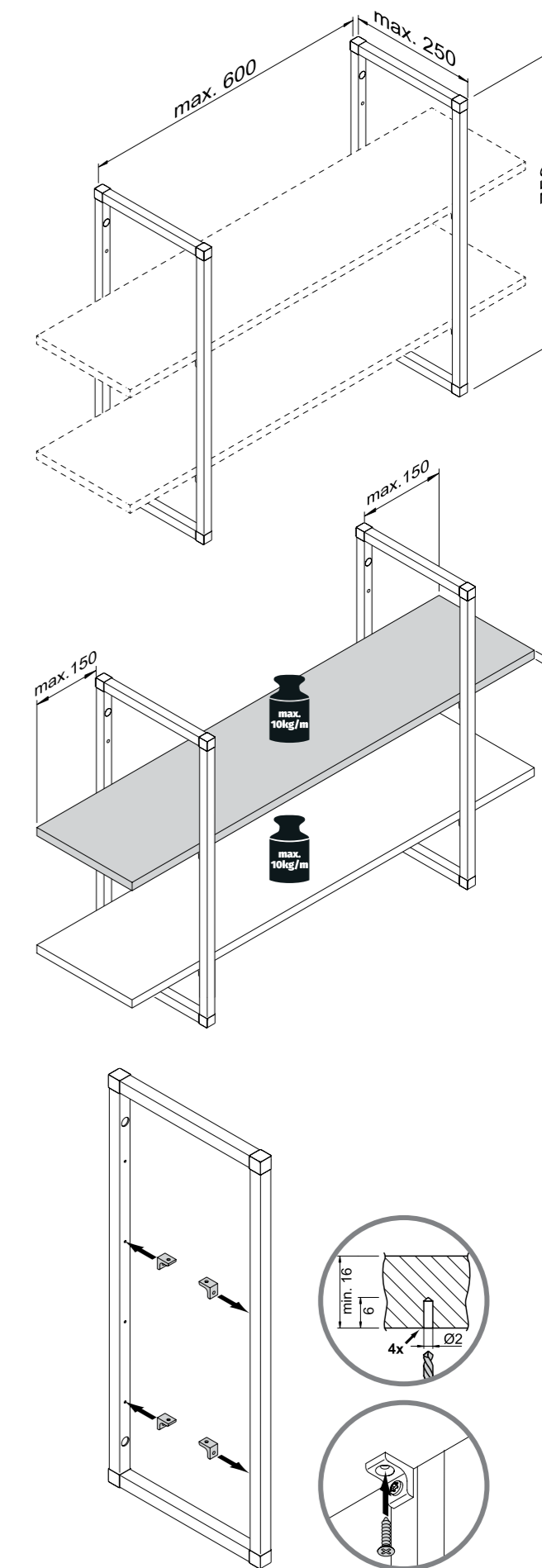

Shelves material: melamine faced/veneered chipboard (thickness min. 16mm), decorative panels TIMBER/SYNCRON/SMART, lacquered MDF with matt finish, HPL. The shelving frame can be wall or worktop mounted.

Material der Einlegeböden: melaminbeschichtete/furnierte Spanplatte (Stärke min. 16mm), Dekorplatten TIMBER/SYNCRON/SMART, lackierte MDF-Platte in matter Ausführung, HPL. Der Regalrahmen wird an die Wand oder auf die Arbeitsplatte montiert.

SmartCube**SmartCube Shelving system SmartCube Regalsystem**

Type 1 Ausführung 1



Two shelves Zwei Einlegeböden

Type 2 Ausführung 2

Three and more shelves (vertical extension only)
Drei und mehr Einlegeböden (nur vertikale Erweiterung)

Type 1 Ausführung 1

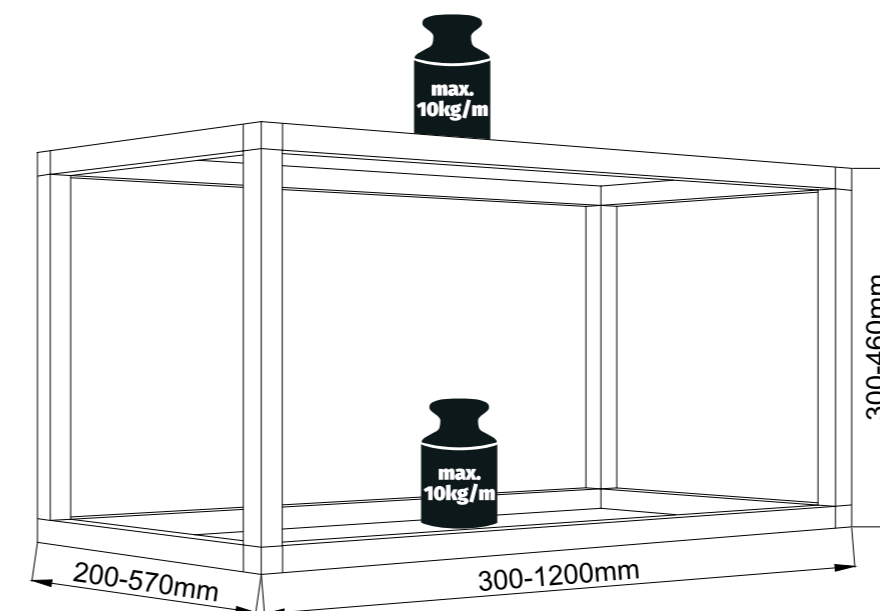

Type 2 Ausführung 2

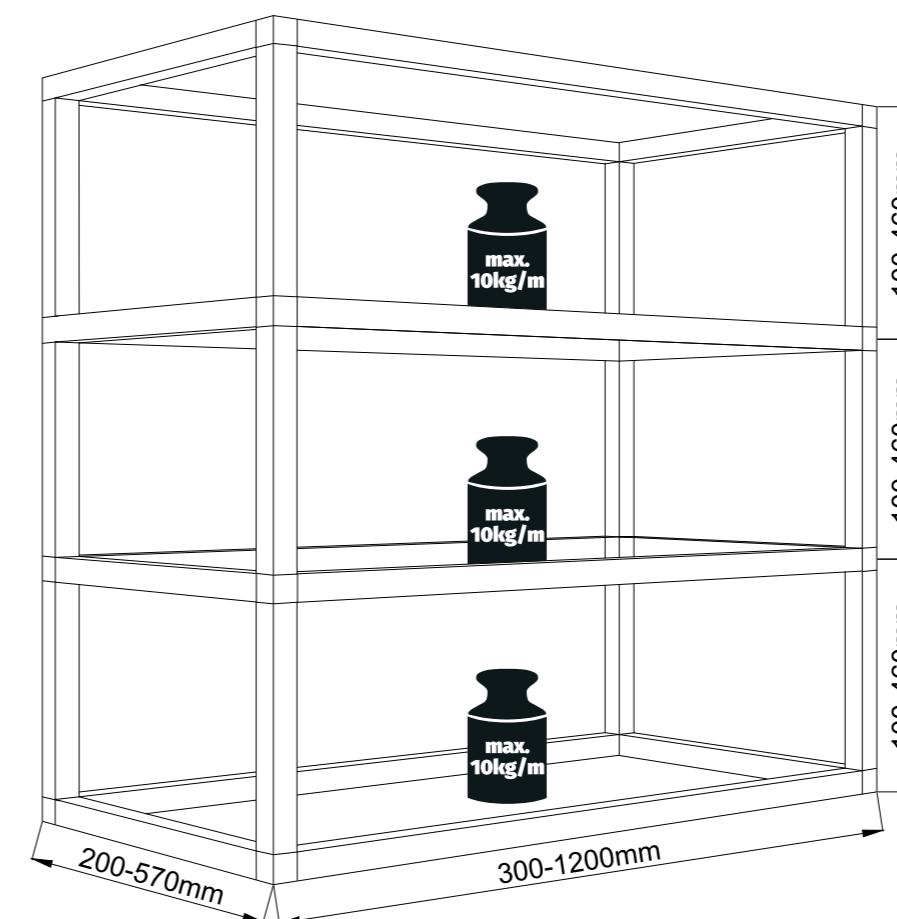

Shelves material: melamine faced/veneered chipboard (thickness up to 19mm), glass, decorative panels TIMBER/SYNCRON/SMART, lacquered MDF with matt finish, HPL.

The shelving system can be extended only vertically.

Side extension is possible by installing several self-supporting systems side by side.

The shelving system can be wall or worktop mounted.

Material der Einlegeböden: melaminbeschichtete/furnierte Spanplatte (Stärke bis zu 19mm), Glas, Dekorplatten TIMBER/SYNCRON/SMART, lackierte MDF-Platte in matter Ausführung, HPL.

Das Regalsystem kann nur vertikal erweitert werden.

Seitliche Erweiterung ist durch Nebenmontage von mehreren unabhängigen Systemen möglich.

Das Regalsystem wird an die Wand oder auf die Arbeitsplatte montiert.

Tara storage tray Ablagewanne Tara

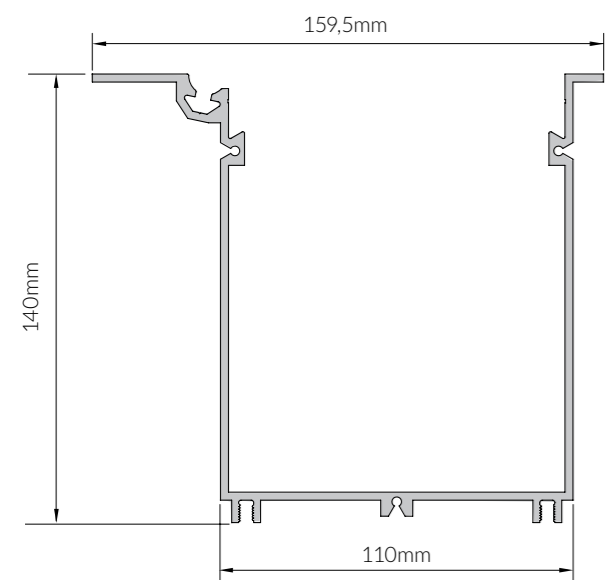

Trough, width 900mm
Wanne, Breite 900mm

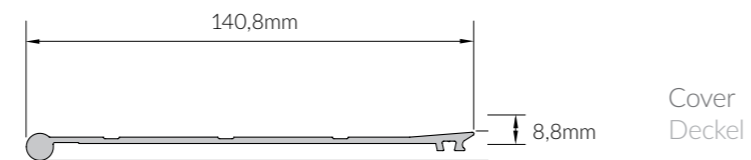

Cover
Deckel

Accessories for Tara storage tray
Zubehör für Ablagewanne Tara



1
Bottle holder Flaschenhalter



2
Knife block Messerblock



3
Worktop bowl
Aufsatzschale

Complete your Tara storage tray with the following options:
Kompletieren Sie Ihre Ablagewanne Tara mit den folgenden Optionen:

1+3 or **2+3**

Groove hanging rail Einhängeschiene Groove



Accessories for Groove hanging rail
Zubehör für Einhängeschiene Groove



Roller holder Rollenhalter



Knife block Messerblock



Hook rail Hakenleiste

Metropolis Waste bin system Metropolis Abfalltrennsystem

Available for drawers with the following runners/drawer systems:

ball-bearing runners (nominal runners length 500mm)

InnoTech (nominal runners length 470mm)

ArciTech (nominal runners length 500mm)

Not available for drawers with Quadro 25 runners and Uniset Metal Box drawer system

Available for drawers with concealed pull grips C-1, C-2, C-3 and integrated VOLPATO profile

Geeignet für Auszüge mit den folgenden Führungen/Auszugssystemen:

Kugelauszugsführungen (Nennlänge der Führungen 500mm)

InnoTech (Nennlänge der Führungen 470mm)

ArciTech (Nennlänge der Führungen 500mm)

Nicht geeignet für Auszüge mit Führungen Quadro 25 und Schubkastensysteme Uniset Metal Box

Geeignet für Auszüge mit verdeckten Griffleisten C-1, C-2, C-3 und integriertem Profil VOLPATO

Bins: plastic in dark grey, handles: plastic in light grey
Eimer: Kunststoff in dunkelgrau, Griffe: Kunststoff in hellgrau

Set options Set-Varianten

Cabinet width 600mm Korpusbreite 600mm



L-60

2 bins with lids
Bins height 220mm
Bins capacity 2x12l
Set 2 small trays,
2 narrow dividers

2 Eimer mit Deckel Eimerhöhe
220mm Fassungsvermögen
2x12l Set 2 kleine
Einsatzwannen, 2 enge
Trennelemente



XL-60

2 bins with lids
Bins height 280mm
Bins capacity 2x15l
Set 2 small trays,
2 narrow dividers

2 Eimer mit Deckel Eimerhöhe
280mm Fassungsvermögen
2x15l Set 2 kleine
Einsatzwannen, 2 enge
Trennelemente

Cabinet width 900mm Korpusbreite 900mm

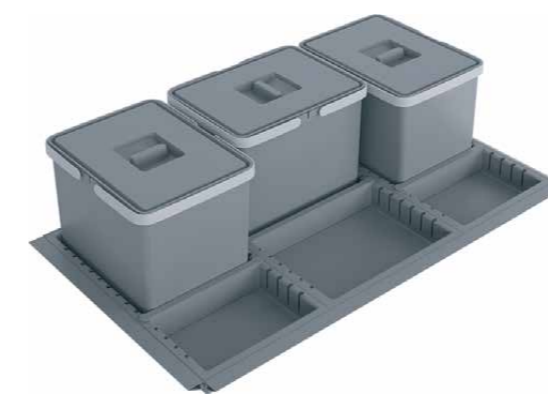

L-90

3 bins with lids
Bins height 220mm
Bins capacity 3x12l
Set 2 small trays,
1 large tray,
2 narrow dividers,
1 wide divider

3 Eimer mit Deckel Eimerhöhe
220mm Fassungsvermögen
3x12l Set 2 kleine
Einsatzwannen,

1 große Einsatzwanne,
2 enge Trennelemente,
1 breites Trennelement

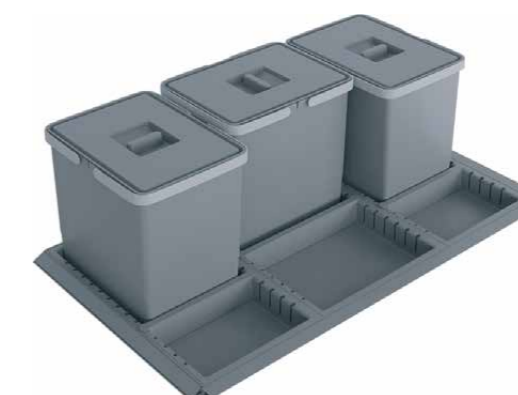

XL-90

3 bins with lids
Bins height 280mm
Bins capacity 3x15l
Set 2 small trays,
1 large tray,
2 narrow dividers,
1 wide divider

3 Eimer mit Deckel Eimerhöhe
280mm Fassungsvermögen
3x15l Set 2 kleine
Einsatzwannen,

1 große Einsatzwanne,
2 enge Trennelemente,
1 breites Trennelement

Cabinet width 1200mm Korpusbreite 1200mm

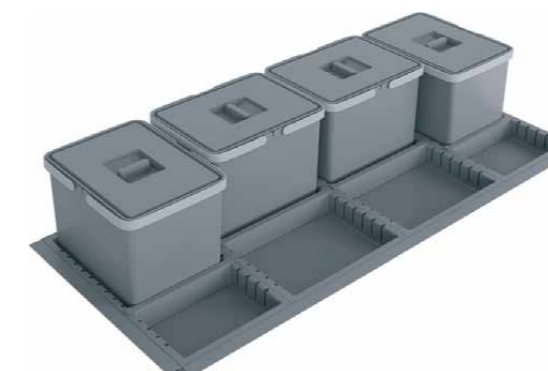

L-120

4 bins with lids
Bins height 220mm
Bins capacity 4x12l
Set 2 small trays,
2 large trays,
2 narrow dividers,
2 wide dividers

4 Eimer mit Deckel Eimerhöhe
220mm Fassungsvermögen
4x12l Set 2 kleine
Einsatzwannen, 2 große
Einsatzwannen,
2 enge Trennelemente,
2 breite Trennelemente

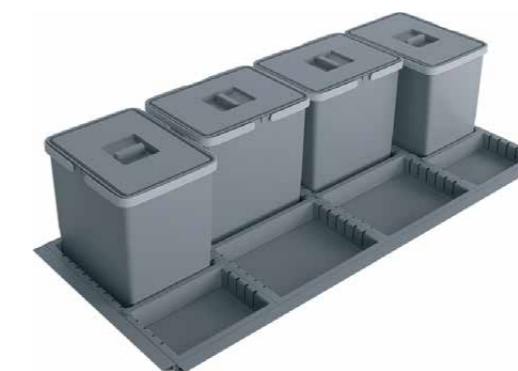

XL-120

4 bins with lids
Bins height 280mm
Bins capacity 4x15l
Set 2 small trays,
2 large trays,
2 narrow dividers,
2 wide dividers

4 Eimer mit Deckel Eimerhöhe
280mm Fassungsvermögen
4x15l Set 2 kleine
Einsatzwannen, 2 große
Einsatzwannen,
2 enge Trennelemente,
2 breite Trennelemente

Additional bins and dividers Zusätzliche Eimer und Trennelemente



DBN-L12

Dimensions (WxDxH) 225x300x220mm, capacity 12l
Größe (BxTxH) 225x300x220mm, Fassungsvermögen 12l

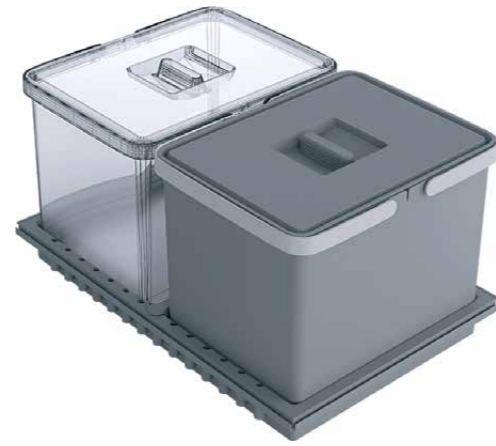

Additional installation into a large tray
Zusätzliche Installation in eine große Einsatzwanne



DBN-XL15

Dimensions (WxDxH) 225x300x280mm, capacity 15l
Größe (BxTxH) 225x300x280mm, Fassungsvermögen 15l



Additional installation into a large tray
Zusätzliche Installation in eine große Einsatzwanne



DBN-XL6

Dimensions (WxDxH) 225x150x280mm, capacity 6l
Größe (BxTxH) 225x150x280mm, Fassungsvermögen 6l



Additional installation into a small tray
Zusätzliche Installation in eine kleine Einsatzwanne



Additional installation into a large tray (2 pcs.)
Zusätzliche Installation in eine große Einsatzwanne (2 Stück)

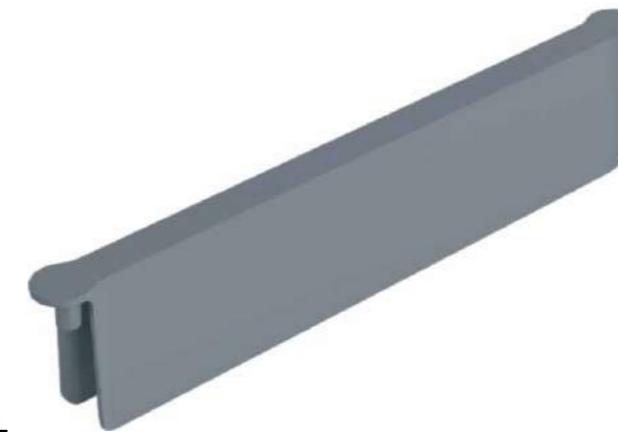

DVR-L

Divider for a small tray
Material plastic in dark grey color

Trennelement für eine kleine Einsatzwanne
Material Kunststoff in dunkelgrau

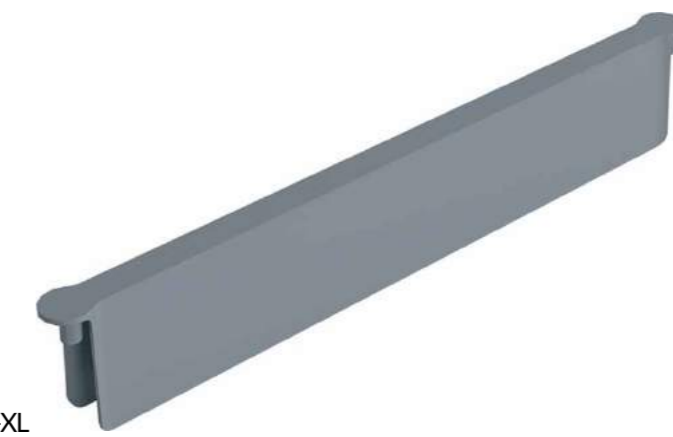

DVR-XL

Divider for a large tray
Material plastic in dark grey color

Trennelement für eine große Einsatzwanne
Material Kunststoff in dunkelgrau

Door mounted swing out waste bin
Einbau-Abfallsammler für
Seitenmontage



Cabinet width min. 400mm
Door width min. 396mm
Capacity 8 litres
Color Chrome

Korpusbreite min. 400mm
Türbreite min. 396mm
Fassungsvermögen 8 Liter
Farbe Chrom

Laminate with magnetic surface Schichtstoff mit magnetischer Oberfläche



Can be used as front center panel or splashback/wall board
 Strong magnetic effect
 Can be written on with chalks or special board markers
 Maximum length 3050mm
 Maximum height 1220mm
 Thickness 4mm (as front center panel)
 Thickness 8mm (as splashback/wall board)

Einsetzbar als Frontfüllung oder Spritzschutz/Wandtafel
 Stark magnetisch
 Man kann darauf mit Kreiden oder speziellen Boardmarkern schreiben
 Länge max. 3050mm
 Höhe max. 1220mm
 Stärke 4mm (als Frontfüllung)
 Stärke 8mm (als Spritzschutz/Wandtafel)

Plastic cutlery tray Kunststoffbesteckeinsatz



Cabinet width 300, 400, 500, 600, 700, 800, 900mm
 Korpusbreite 300, 400, 500, 600, 700, 800, 900mm

One-tier draining rack Abtropfgestell (1 Ebene)

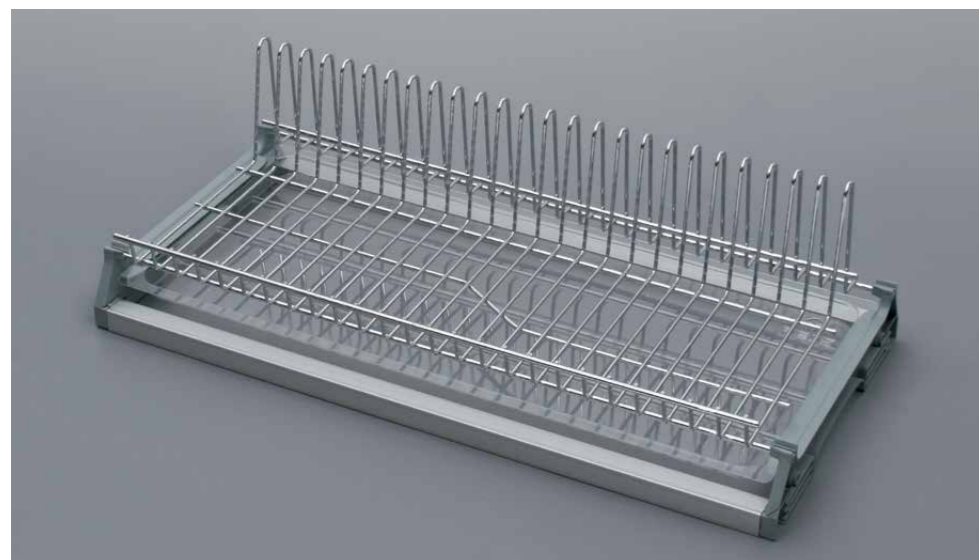

Cabinet width 600, 900mm
 Color Chrome
 Korpusbreite 600, 900mm
 Farbe Chrom

Two-tier draining rack Abtropfgestell (2 Ebenen)



Cabinet width 500, 600, 700, 800, 900mm
 Color Chrome
 Korpusbreite 500, 600, 700, 800, 900mm
 Farbe Chrom

Anti-slip mat for inserting into the drawer or pot-and-pan drawer
 Antirutschmatte zum Einlegen in den Schubkasten oder Frontauszug



Width 475mm
 Color anthracite Suitable for ArciTech
 Breite 475mm
 Farbe Anthrazit
 Für ArciTech geeignet



Width 480mm
 Color white
 Breite 480mm
 Farbe weiß



Width 480mm
 Color grey
 Breite 480mm
 Farbe grau



KITCHEN APPLIANCES

KÜCHENGERÄTE

HOBS

KOCHFELDER, KOCHMULDEN



The PowerBoost function for an instant burst of heat
PowerBoost-Funktion für einen sofortigen Aufheizimpuls



The Bridge / CombiZone function for combining two separate cooking zones
Bridge-/CombiZone-Funktion für Verbindung von zwei Kochzonen



The Stop&Go function in case of unexpected interruptions
Stop&Go Funktion bei unerwarteten Unterbrechungen



2-/3-level residual heat indicator
2-/3-stufige Restwärmeanzeige



The Hob2Hood function for automatic control of the hood settings
Hob2Hood-Funktion zur automatischen Aktivierung der Dunstabzugshaube



TouchSensor control
TouchSensor-Bedienung



Cable length, m
Kabellänge, m



Total electricity loading, W
Max. Gesamtanschlusswert, Watt

Built-in gas hobs Einbau-Gaskochmulden

Electrolux



GPE363RBK

Surface material: tempered glass (color black)
Control type: gas taps (copper-like color)
Number of burners: 4
TripleCrown speed burner
Flame failure safety
Automatic hob ignition
BridgeBurner's cast-iron pan supports
Hob dimensions, mm: 590x520
Aperture dimensions (HxWxD), mm: 46x560x480

Material der Oberfläche: Hartglas (Farbe schwarz) Bedienung:
Bedienknebel (Farbe kupferähnlich)
Anzahl der Brenner: 4
Hochleistungsbrenner TripleCrown
Gassicherung
Elektro-Takt-Funkenzündung
Gußeiserne Topfträger BridgeBurner
Gerätemaße, mm: 590x520
Ausschnittmaße (HxBxT), mm: 46x560x480

Electrolux



GPE363RBV

Surface material: tempered glass (color cream)
Control type: gas taps (copper-like color)
Number of burners: 4
TripleCrown speed burner
Flame failure safety
Automatic hob ignition
BridgeBurner's cast-iron pan supports
Hob dimensions, mm: 590x520
Aperture dimensions (HxWxD), mm: 46x560x480

Material der Oberfläche: Hartglas (Farbe Creme)
Bedienung: Bedienknebel (Farbe kupferähnlich)
Anzahl der Brenner: 4
Hochleistungsbrenner TripleCrown
Gassicherung
Elektro-Takt-Funkenzündung
Gußeiserne Topfträger BridgeBurner
Gerätemaße, mm: 590x520
Ausschnittmaße (HxBxT), mm: 46x560x480



GPE263MX

Surface material: stainless steel
 Control type: gas taps (color black + stainless steel)
 Number of burners: 4
 TripleCrown speed burner
 Flame failure safety
 Automatic hob ignition
 BridgeBurner's cast-iron pan supports
 Hob dimensions, mm: 595x510
 Aperture dimensions (HxWxD), mm: 40x560x480

Material der Oberfläche: Edelstahl
 Bedienung: Bedienknebel (Farbe schwarz + Edelstahl)
 Anzahl der Brenner: 4
 Hochleistungsbrenner TripleCrown
 Gassicherung
 Elektro-Takt-Funkenzündung
 Gußeiserne Topfträger BridgeBurner
 Gerätemaße, mm: 595x510
 Ausschnittmaße (HxBxT), mm: 40x560x480

AEG



HG567455VB

Surface type: «Gas on glass» (color black)
 Control type: gas taps (color black)
 Number of burners: 4
 TripleCrown speed burner
 Flame failure safety
 Automatic hob ignition
 Cast-iron pan supports
 Hob dimensions, mm: 590x520
 Aperture dimensions (HxWxD), mm: 46x560x480

Art der Oberfläche: «Gas auf Glas» (Farbe schwarz)
 Bedienung: Bedienknebel (Farbe schwarz)
 Anzahl der Brenner: 4
 Hochleistungsbrenner TripleCrown
 Gassicherung
 Elektro-Takt-Funkenzündung
 Gußeiserne Topfträger
 Gerätemaße, mm: 590x520
 Ausschnittmaße (HxBxT), mm: 46x560x480

BOSCH



PGP6B6O90R

Surface material: enameled steel (color black)
 Control type: gas taps (color stainless steel)
 Number of burners: 4
 Flame failure safety
 Automatic hob ignition
 Cast-iron pan supports
 LPG jets included
 Hob dimensions, mm: 582x520
 Aperture dimensions (HxWxD), mm: 56x560x480-490

Material der Oberfläche: Stahl emailliert (Farbe schwarz)
 Bedienung: Bedienknebel (Farbe Edelstahl)
 Anzahl der Brenner: 4
 Thermoelektrische Zündsicherung
 Elektro-Takt-Funkenzündung
 Gußeiserne Topfträger
 Flüssiggas-Düsen beiliegend
 Gerätemaße, mm: 582x520
 Ausschnittmaße (HxBxT), mm: 56x560x480-490

BOSCH



PPP6A2B20

Surface material: tempered glass HardGlass (color white)
 Control type: gas taps (color black + stainless steel)
 Number of burners: 4
 FlameSelect for a precise adjustment of the flame in 9 defined levels
 Flame failure safety
 Automatic hob ignition
 Cast-iron pan supports
 LPG jets included
 Hob dimensions, mm: 590x520
 Aperture dimensions (HxWxD), mm: 56x560x480-490

Material der Oberfläche: Hartglas (Farbe weiß)
 Bedienung: Bedienknebel (Farbe schwarz + Edelstahl)
 Anzahl der Brenner: 4
 FlameSelect für eine präzise Flammenregulierung in 9 definierten Stufen
 Thermoelektrische Zündsicherung
 Elektro-Takt-Funkenzündung
 Gußeiserne Topfträger
 Flüssiggas-Düsen beiliegend
 Gerätemaße, mm: 590x520
 Ausschnittmaße (HxBxT), mm: 56x560x480-490

Built-in induction hobs Einbau-Induktionskochfelder

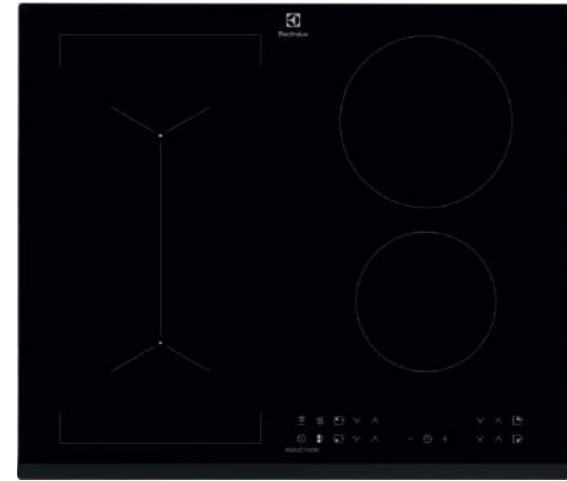
 Electrolux

IPE6443KF

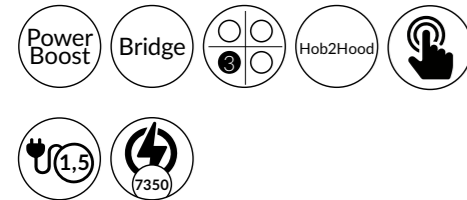

Material: glass ceramic (color black)
Frame type: frameless, 1 bevelled side
Control type: Touch Control with LED lighting
 Automatic detection of the size of cookware
 Safety control lock function
 Timer for all cooking zones
Hob dimensions, mm: 590x520
Aperture dimensions (HxWxD), mm: 44x560x490

Material: Glaskeramik (Farbe schwarz) **Rahmenart:** rahmenlos, 1 abgeschrägte Seite **Bedienung:** Touch Control mit LED-Beleuchtung
 Automatische Erkennung der Topfbodengröße
 Verriegelungsfunktion
 Timer für alle Kochzonen
Gerätemaße, mm: 590x520
Ausschnittmaße (HxBxT), mm: 44x560x490

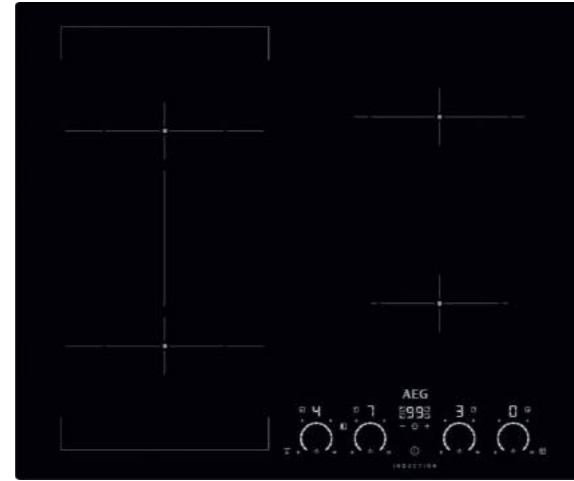

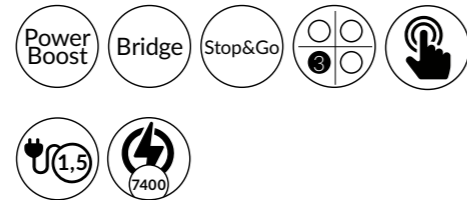

IKK64451B

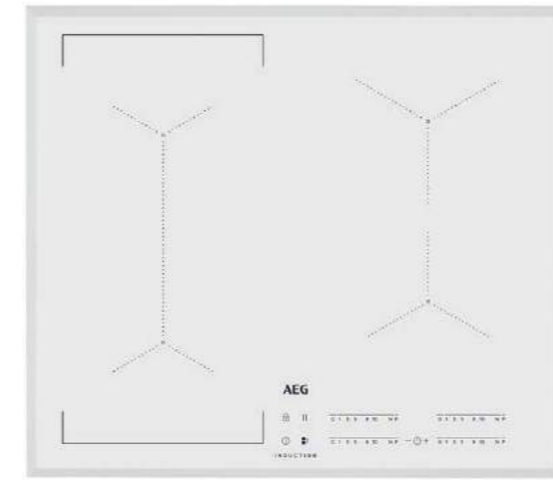

Material: glass ceramic (color black)
Frame type: frameless
Control type: Touch Slider Direct Access with LED lighting
 Automatic detection of the size of cookware
 Safety control lock function
 Timer for all cooking zones
Hob dimensions, mm: 580x510
Aperture dimensions (HxWxD), mm: 59x560x490

Material: Glaskeramik (Farbe schwarz) **Rahmenart:** rahmenlos
Bedienung: Touch Slider Direct Access mit LED-Beleuchtung
 Automatische Erkennung der Topfbodengröße
 Verriegelungsfunktion
 Timer für alle Kochzonen
Gerätemaße, mm: 580x510
Ausschnittmaße (HxBxT), mm: 59x560x490

IKR64443FW

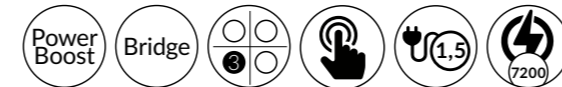

Material: glass ceramic (color white)
Frame type: frame with 4 bevelled sides **Control type:** Touch Slider Direct Access with LED lighting
 Automatic detection of the size of cookware
 Safety control lock function
 Timer for all cooking zones
Hob dimensions, mm: 590x520
Aperture dimensions (HxWxD), mm: 44x560x490

Material: Glaskeramik (Farbe weiß) **Rahmenart:** Rahmen mit 4 abgeschrägten Seiten
Bedienung: Touch Slider Direct Access mit LED-Beleuchtung
 Automatische Erkennung der Topfbodengröße
 Verriegelungsfunktion
 Timer für alle Kochzonen
Gerätemaße, mm: 590x520
Ausschnittmaße (HxBxT), mm: 44x560x490

Built-in induction hobs Einbau-Induktionskochfelder

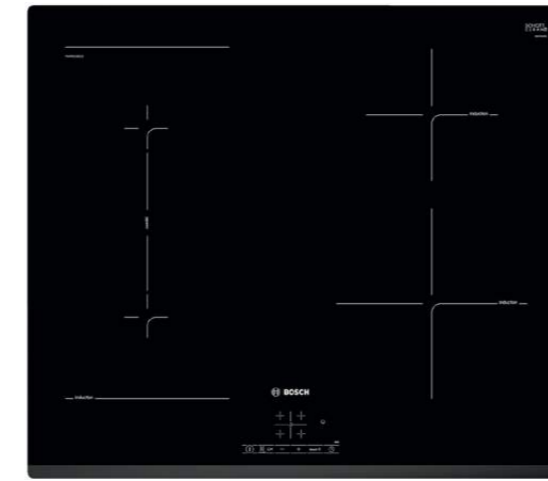

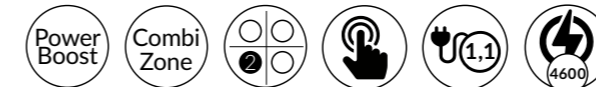

PWP631BB1E

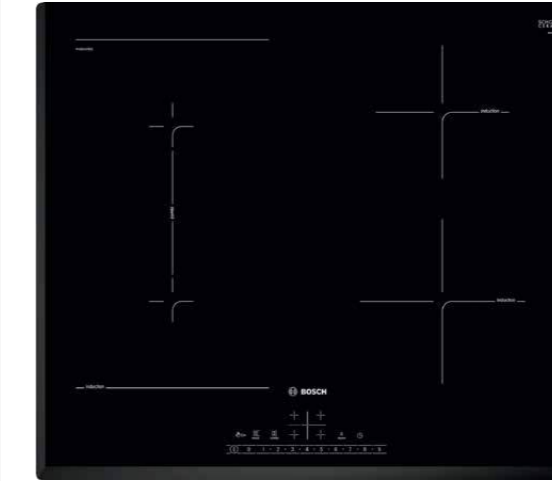

Material: glass ceramic (color black)
Frame type: frameless, 1 bevelled side
Control type: TouchSelect
 Automatic detection of cookware
 17-stage power settings for each zone
 Safety control lock function
 Timer for all cooking zones
Hob dimensions, mm: 592x522
Aperture dimensions (HxWxD), mm: 51x560x490-500

Material: Glaskeramik (Farbe schwarz) **Rahmenart:** rahmenlos, 1 abgeschrägte Seite
Bedienung: TouchSelect
 Topferkennung
 17 Leistungsstufen für jede Kochzone
 Verriegelungsfunktion
 Timer für alle Kochzonen
Gerätemaße, mm: 592x522
Ausschnittmaße (HxBxT), mm: 51x560x490-500



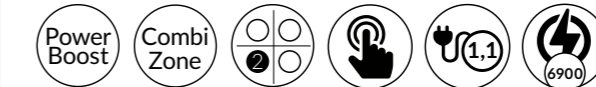

PVS651FB5E

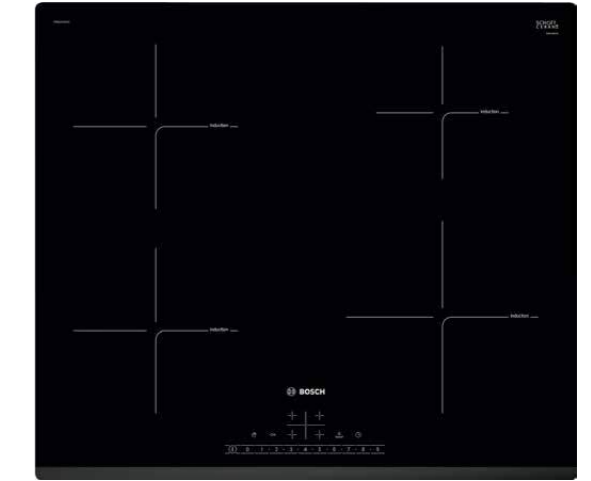

Material: glass ceramic (color black)
Frame type: frameless, 3 bevelled sides **Control type:** DirectSelect
 Automatic detection of cookware
 17-stage power settings for each zone
 Safety control lock function
 Timer for all cooking zones
Hob dimensions, mm: 592x522
Aperture dimensions (HxWxD), mm: 51x560x490-500

Material: Glaskeramik (Farbe schwarz) **Rahmenart:** rahmenlos, 3 abgeschrägte Seiten
Bedienung: DirectSelect
 Topferkennung
 17 Leistungsstufen für jede Kochzone
 Verriegelungsfunktion
 Timer für alle Kochzonen
Gerätemaße, mm: 592x522
Ausschnittmaße (HxBxT), mm: 51x560x490-500

PIE631FB1E



Material: glass ceramic (color black)
Frame type: frameless, 1 bevelled side
Control type: DirectSelect
 Automatic detection of cookware
 17-stage power settings for each zone
 Safety control lock function
 Timer for all cooking zones
Hob dimensions, mm: 592x522
Aperture dimensions (HxWxD), mm: 51x560x490-500

Material: Glaskeramik (Farbe schwarz) **Rahmenart:** rahmenlos, 1 abgeschrägte Seite
Bedienung: DirectSelect
 Topferkennung
 17 Leistungsstufen für jede Kochzone
 Verriegelungsfunktion
 Timer für alle Kochzonen
Gerätemaße, mm: 592x522
Ausschnittmaße (HxBxT), mm: 51x560x490-500

OVENS BACKÖFEN

Built-in ovens Einbaubackfen



EZB52430AX

Color: stainless steel with Antifingerprint coating
 Cleaning: easy clean enamel
 Temperature range: 50°C - 250°C
 Double glass door
 Retractable oven controls
 Rail type: 1 level telescopic
 Accessories: 1 drip pan (easy clean enamel), 1 grid (chrome plated)
 Appliance dimensions (HxWxD), mm: 590x594x560
 Niche dimensions (HxWxD), mm: 593x560x550

Farbe: Edelstahl mit Anti-Fingerabdruckbeschichtung
 Reinigung: leicht zu reinigende Emaille
 Temperaturbereich: 50°C - 250°C
 Doppelglastür
 Versenkbare Bedienknebel
 Art des Auszugs: 1-facher Teleskopauszug
 Zubehör: 1 Fettpfanne (leicht zu reinigende Emaille), 1 Gitterrost (chrombeschichtet)
 Gerätemaße (HxBxT), mm: 590x594x560
 Nischenmaße (HxBxT), mm: 593x560x550



OPEC5531X

Color: stainless steel with Antifingerprint coating
 Cleaning: pyrolytic self-cleaning function
 Temperature range: 30°C - 300°C
 Retractable oven controls
 Rail type: easy removable Easy Entry
 Accessories: 1 drip pan, 1 baking tray (easy clean enamel), 1 grid (chrome plated)
 Appliance dimensions (HxWxD), mm: 594x594x568
 Niche dimensions (HxWxD), mm: 600x560x550

Farbe: Edelstahl mit Anti-Fingerabdruckbeschichtung
 Reinigung: pyrolytische Selbstreinigung
 Temperaturbereich: 30°C - 300°C
 Versenkbare Bedienknebel
 Art des Auszugs: leicht abnehmbar Easy Entry
 Zubehör: 1 Fettpfanne, 1 Backblech (leicht zu reinigende Emaille), 1 Gitterrost (chrombeschichtet)
 Gerätemaße (HxBxT), mm: 594x594x568
 Nischenmaße (HxBxT), mm: 600x560x550



Steam function
Dampfgarer



Temperature probe
Kerntemperatursensor



Volume usable, l
Backofenvolumen, L



Number of heating methods
Anzahl der Heizarten



Interior light: halogen
Backofenbeleuchtung: Halogen



Heating type: electric
Heizart: elektrisch



TouchSensor control
TouchSensor-Bedienung



Cable length, m
Kabellänge, m



Energy class
Energieeffizienzklasse



Total electricity loading, W
Max. Gesamtanschlusswert, Watt

 Electrolux

OPEA2550R

Color: black
 Cleaning: easy clean catalytic enamel
 Volume usable, l: 72
 Rail type: easy removable
 Accessories: 1 drip pan, 1 baking tray (easy clean enamel), 1 grid (chrome plated)
 Appliance dimensions (HxWxD), mm: 594x594x568
 Niche dimensions (HxWxD), mm: 600x560x550

Farbe: schwarz
 Reinigung: leicht zu reinigende katalytische Emaille
 Temperaturbereich: 50°C - 275°C
 Art des Auszugs: leicht abnehmbar
 Zubehör: 1 Fettpfanne, 1 Backblech (leicht zu reinigende Emaille), 1 Gitterrost (chrombeschichtet)
 Gerätemaße (HxBxT), mm: 594x594x568
 Nischenmaße (HxBxT), mm: 600x560x550

 Electrolux

OPEA2550V

Color: cream
 Cleaning: easy clean catalytic enamel
 Temperature range: 50°C - 275°C
 Rail type: easy removable
 Accessories: 1 drip pan, 1 baking tray (easy clean enamel), 1 grid (chrome plated)
 Appliance dimensions (HxWxD), mm: 594x594x568
 Niche dimensions (HxWxD), mm: 600x560x550

Farbe: Creme
 Reinigung: leicht zu reinigende katalytische Emaille
 Temperaturbereich: 50°C - 275°C
 Art des Auszugs: leicht abnehmbar
 Zubehör: 1 Fettpfanne, 1 Backblech (leicht zu reinigende Emaille), 1 Gitterrost (chrombeschichtet)
 Gerätemaße (HxBxT), mm: 594x594x568
 Nischenmaße (HxBxT), mm: 600x560x550



BER455120M

Color: stainless steel with Antifingerprint coating
 Cleaning: easy clean enamel
 Steam function SteamBake
 Temperature range: 50°C - 250°C
 Retractable oven controls
 Rail type: 1 level telescopic
 Accessories: 1 drip pan, 1 baking tray (easy clean enamel), 1 grid (chrome plated)
 Appliance dimensions (HxWxD), mm: 594x595x567
 Niche dimensions (HxWxD), mm: 590x560x550

Farbe: Edelstahl mit Anti-Fingerabdruckbeschichtung
 Reinigung: leicht zu reinigende Emaille
 Dampfgarer SteamBake
 Temperaturbereich: 50°C - 250°C
 Versenkbare Bedienknöpfe
 Art des Auszugs: 1-facher Teleskopauszug
 Zubehör: 1 Fettpfanne, 1 Backblech (leicht zu reinigende Emaille), 1 Gitterrost (chrombeschichtet)
 Gerätemaße (HxBxT), mm: 594x595x567
 Nischenmaße (HxBxT), mm: 590x560x550



BER455120B

Color: black
 Cleaning: easy clean enamel
 Steam function SteamBake
 Temperature range: 50°C - 250°C
 Retractable oven controls
 Rail type: 1 level telescopic
 Accessories: 1 drip pan, 1 baking tray (easy clean enamel), 1 grid (chrome plated)
 Appliance dimensions (HxWxD), mm: 594x595x567
 Niche dimensions (HxWxD), mm: 590x560x550

Farbe: schwarz
 Reinigung: leicht zu reinigende Emaille
 Dampfgarer SteamBake
 Temperaturbereich: 50°C - 250°C
 Versenkbare Bedienknöpfe
 Art des Auszugs: 1-facher Teleskopauszug
 Zubehör: 1 Fettpfanne, 1 Backblech (leicht zu reinigende Emaille), 1 Gitterrost (chrombeschichtet)
 Gerätemaße (HxBxT), mm: 594x595x567
 Nischenmaße (HxBxT), mm: 590x560x550

AEG

BCR742350W

Color: white
 Cleaning: easy clean catalytic enamel
 Temperature range: 30°C - 300°C
 Control type: Touch Control
 Rail type: 1 level telescopic
 Accessories: 1 drip pan, 1 baking tray (easy clean enamel), 1 grid (chrome plated)
 Appliance dimensions (HxWxD), mm: 594x595x567
 Niche dimensions (HxWxD), mm: 590x560x550

Farbe: weiß
 Reinigung: leicht zu reinigende katalytische Emaille
 Temperaturbereich: 30°C - 300°C
 Bedienung: Touch Control
 Art des Auszugs: 1-facher Teleskopauszug
 Zubehör: 1 Fettpfanne, 1 Backblech (leicht zu reinigende Emaille), 1 Gitterrost (chrombeschichtet)
 Gerätemaße (HxBxT), mm: 594x595x567
 Nischenmaße (HxBxT), mm: 590x560x550

**BOSCH**

HBG537NB0R

Color: black
 Cleaning: self-cleaning coating EcoClean Direct (back panel)
 AutoPilot 10: 10 pre-set automatic programs
 Temperature range: 50°C - 275°C
 Retractable oven controls
 Rail type: 1 level telescopic
 Accessories: 1 drip pan, 1 baking tray (easy clean enamel), 1 grid (chrome plated)
 Appliance dimensions (HxWxD), mm: 595x594x548
 Niche dimensions (HxWxD), mm: 585-595x560-568x550

Farbe: schwarz
 Reinigung: selbstreinigende Beschichtung EcoClean Direct (Rückwand) AutoPilot 10: 10 voreingestellte Automatikprogramme
 Temperaturbereich: 50°C - 275°C
 Versenkbare Bedienknebel
 Art des Auszugs: 1-facher Teleskopauszug
 Zubehör: 1 Fettpfanne, 1 Backblech (leicht zu reinigende Emaille), 1 Gitterrost (chrombeschichtet)
 Gerätemaße (HxBxT), mm: 595x594x548
 Nischenmaße (HxBxT), mm: 585-595x560-568x550

**BOSCH**

HBG378EW0R

Color: white
 Cleaning: pyrolytic self-cleaning function
 AutoPilot 30: 30 pre-set automatic programs
 Temperature range: 30°C - 275°C
 Control: retractable oven controls / Touch Sensor
 Rail type: 1 level telescopic
 Accessories: 1 drip pan, 1 baking tray (easy clean enamel), 1 grid (chrome plated)
 Appliance dimensions (HxWxD), mm: 595x594x548
 Niche dimensions (HxWxD), mm: 585-595x560-568x550

Farbe: weiß
 Reinigung: pyrolytische Selbstreinigung
 AutoPilot 30: 30 voreingestellte Automatikprogramme
 Temperaturbereich: 30°C - 275°C
 Bedienung: versenkbare Bedienknebel / Touch Sensor
 Art des Auszugs: 1-facher Teleskopauszug
 Zubehör: 1 Fettpfanne, 1 Backblech (leicht zu reinigende Emaille), 1 Gitterrost (chrombeschichtet)
 Gerätemaße (HxBxT), mm: 595x594x548
 Nischenmaße (HxBxT), mm: 585-595x560-568x550

**BOSCH**

HBF114ES0R

Color: black / stainless steel
 Cleaning: easy clean enamel
 Temperature range: 50°C - 275°C
 Retractable oven controls
 Rail type: 1 level telescopic
 Accessories: 1 drip pan, 1 baking tray (easy clean enamel), 1 grid (chrome plated)
 Appliance dimensions (HxWxD), mm: 595x594x548
 Niche dimensions (HxWxD), mm: 575-597x560-568x550

Farbe: schwarz / Edelstahl
 Reinigung: leicht zu reinigende Emaille
 Temperaturbereich: 50°C - 275°C
 Versenkbare Bedienknebel
 Art des Auszugs: 1-facher Teleskopauszug
 Zubehör: 1 Fettpfanne, 1 Backblech (leicht zu reinigende Emaille), 1 Gitterrost (chrombeschichtet)
 Gerätemaße (HxBxT), mm: 595x594x548
 Nischenmaße (HxBxT), mm: 575-597x560-568x550



MICROWAVE OVENS

MIKROWELLEN

Built-in microwave ovens
Einbaumikrowellen

Electrolux



EMT25203OK

Color: black
 Cavity material: stainless steel
 Door mechanism: handle
 Maximum microwave output, W: 900
 Power levels: 8
 Cooking modes: grill, microwave, microwave & grill
 Grill feature: 1000W quartz grill
 Automatic programs: defrost by weight, cooking by weight
 Turntable: 315mm, glass
 Accessories: grill rack
 Appliance dimensions (HxWxD), mm: 388x595x401
 Niche dimensions (HxWxD), mm: 380x560x500

Farbe: schwarz
 Material, Innenraum: Edelstahl
 Türmechanismus: Griff
 Max. Mikrowellenleistung, Watt: 900
 Leistungsstufen: 8
 Beheizungsarten: Grill, Mikrowellenfunktion, Mikrowellenfunktion & Grill
 Grillfunktion: Quarzgrill, Leistung 1000W
 Automatikprogramme: Gewichtsautomatik für Auftau- und Garprogramme
 Drehteller: 315mm, Glas
 Zubehör: Grillrost
 Gerätegröße (HxBxT), mm: 388x595x401
 Einbaumaße (HxBxT), mm: 380x560x500

Electrolux



EMT25203OC

Color: cream
 Cavity material: stainless steel
 Door mechanism: handle
 Maximum microwave output, W: 900
 Power levels: 8
 Cooking modes: grill, microwave, microwave & grill
 Grill feature: 1000W quartz grill
 Automatic programs: defrost by weight, cooking by weight
 Turntable: 315mm, glass
 Accessories: grill rack
 Appliance dimensions (HxWxD), mm: 388x595x401
 Niche dimensions (HxWxD), mm: 380x560x500

Farbe: Creme
 Material, Innenraum: Edelstahl
 Türmechanismus: Griff
 Max. Mikrowellenleistung, Watt: 900
 Leistungsstufen: 8
 Beheizungsarten: Grill, Mikrowellenfunktion, Mikrowellenfunktion & Grill
 Grillfunktion: Quarzgrill, Leistung 1000W
 Automatikprogramme: Gewichtsautomatik für Auftau- und Garprogramme
 Drehteller: 315mm, Glas
 Zubehör: Grillrost
 Gerätegröße (HxBxT), mm: 388x595x401
 Einbaumaße (HxBxT), mm: 380x560x500

Grill feature
GrillfunktionTouchSensor control
TouchSensor-BedienungCable length, m
Kabellänge, mTotal electricity loading, W
Max. Gesamtanschlusswert, Watt

AEG



MBB1756D-M

Цвет: нержавеющая сталь с покрытием Antifingerprint
Материал внутренней камеры: эмалированная сталь
Механизм открытия двери: нажим
Мощность микроволн, Вт: 800
Количество уровней мощности: 5
Режимы работы: гриль, микроволны, микроволны и гриль
Функция гриля: мощность 800Вт
Автоматические программы: размораживания и приготовления по весу
Вращающийся поднос: 272мм, стекло
Аксессуары: решетка для гриля
Габариты (ВхШхГ), мм: 371x594x316
Размеры для встраивания (ВхШхГ), мм: 360x562x300

Color: stainless steel with Antifingerprint coating
Cavity material: painted steel
Door mechanism: release button
Maximum microwave output, W: 800
Power levels: 5
Cooking modes: grill, microwave, microwave & grill
Grill feature: 800W quartz grill
Automatic programs: defrost by weight, cooking by weight
Turntable: 272 mm, glass
Accessories: grill rack
Appliance dimensions (HxWxD), mm: 371x594x316
Niche dimensions (HxWxD), mm: 360x562x300

Farbe: Edelstahl mit Anti-Fingerabdruckbeschichtung
Material, Innenraum: lackierter Stahl
Türmechanismus: Taste
Max. Mikrowellenleistung, Watt: 800
Leistungsstufen: 5
Beheizungsarten: Grill, Mikrowellenfunktion, Mikrowellenfunktion & Grill
Grillfunktion: Quarzgrill, Leistung 800W
Automatikprogramme: Gewichtsautomatik für Auftau- und Garprogramme
Drehteller: 272mm, Glas
Zubehör: Grillrost
Gerätemaße (HxBxT), mm: 371x594x316
Einbaumaße (HxBxT), mm: 360x562x300

AEG



MBE2658S-W

Цвет: белый
Материал внутренней камеры: эмалированная сталь
Механизм открытия двери: нажим
Мощность микроволн, Вт: 900
Количество уровней мощности: 5
Режимы работы: микроволны
Автоматические программы: размораживания и приготовления по весу
Вращающийся поднос: 325мм, стекло
Габариты (ВхШхГ), мм: 459x596x404
Размеры для встраивания (ВхШхГ), мм: 450x562x500

Color: white
Cavity material: painted steel
Door mechanism: release button
Maximum microwave output, W: 900
Power levels: 5
Cooking modes: microwave
Automatic programs: defrost by weight, cooking by weight
Turntable: 325mm, glass
Appliance dimensions (HxWxD), mm: 459x596x404
Niche dimensions (HxWxD), mm: 450x562x500

Farbe: weiß
Material, Innenraum: lackierter Stahl
Türmechanismus: Taste
Max. Mikrowellenleistung, Watt: 900
Leistungsstufen: 5
Beheizungsarten: Mikrowellenfunktion
Automatikprogramme: Gewichtsautomatik für Auftau- und Garprogramme
Drehteller: 325mm, Glas
Gerätemaße (HxBxT), mm: 459x596x404
Einbaumaße (HxBxT), mm: 450x562x500

BOSCH



BEL524MBO

Цвет: черный
Материал внутренней камеры: нержавеющая сталь
Механизм открытия двери: Touch Control
Мощность микроволн, Вт: 800
Количество уровней мощности: 5
Режимы работы: гриль, микроволны, микроволны и гриль
Функция гриля: мощность 1000Вт
AutoPilot 8: 8 предустановленных автоматических программ
Управление: сенсорное Touch Control / утапливаемый переключатель
Вращающийся поднос: 255мм, стекло
Габариты (ВхШхГ), мм: 382x594x317
Размеры для встраивания (ВхШхГ), мм: 362-365x560-568x300

Color: black
Cavity material: stainless steel
Door mechanism: Touch Control
Maximum microwave output, W: 800
Power levels: 5
Cooking modes: grill, microwave, microwave & grill
Grill feature: 1000W quartz grill
AutoPilot 8: 8 pre-set automatic programs
Control: Touch Control / retractable control
Turntable: 255mm, glass
Appliance dimensions (HxWxD), mm: 382x594x317
Niche dimensions (HxWxD), mm: 362-365x560-568x300

Farbe: schwarz
Material, Innenraum: Edelstahl
Türmechanismus: Touch Control
Max. Mikrowellenleistung, Watt: 800
Leistungsstufen: 5
Beheizungsarten: Grill, Mikrowellenfunktion, Mikrowellenfunktion & Grill
Grillfunktion: Quarzgrill, Leistung 1000W
AutoPilot 8: 8 voreingestellte Automatikprogramme
Bedienung: Touch Control / versenkbarer Bedienknebel
Drehteller: 255mm, Glas
Gerätemaße (HxBxT), mm: 382x594x317
Einbaumaße (HxBxT), mm: 362-365x560-568x300

BOSCH

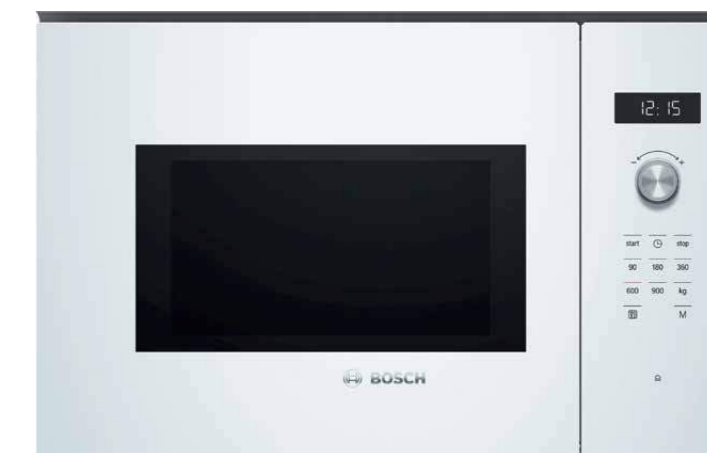

BFL554MW0

Цвет: белый
Материал внутренней камеры: нержавеющая сталь
Механизм открытия двери: Touch Control
Мощность микроволн, Вт: 900
Количество уровней мощности: 5
Режимы работы: микроволны
AutoPilot 7: 7 предустановленных автоматических программ
Управление: сенсорное Touch Control / утапливаемый переключатель
Вращающийся поднос: 315мм, стекло
Габариты (ВхШхГ), мм: 382x594x388
Размеры для встраивания (ВхШхГ), мм: 380-382x560-568x550

Color: white
Cavity material: stainless steel
Door mechanism: Touch Control
Maximum microwave output, W: 900
Power levels: 5
Cooking modes: microwave
AutoPilot 7: 7 pre-set automatic programs
Control: Touch Control / retractable control
Turntable: 315mm, glass
Appliance dimensions (HxWxD), mm: 382x594x388
Niche dimensions (HxWxD), mm: 380-382x560-568x550

Farbe: weiß
Material, Innenraum: Edelstahl
Türmechanismus: Touch Control
Max. Mikrowellenleistung, Watt: 900
Leistungsstufen: 5
Beheizungsarten: Mikrowellenfunktion
AutoPilot 7: 7 voreingestellte Automatikprogramme
Bedienung: Touch Control / versenkbarer Bedienknebel
Drehteller: 315mm, Glas
Gerätemaße (HxBxT), mm: 382x594x388
Einbaumaße (HxBxT), mm: 380-382x560-568x550

DISHWASHERS GESCHIRRSPÜLER



Water sensor
Wassersensor



AirDry Technology
AirDry-Technologie



Noise level, dB
Geräuschpegel, dB



AquaSensor regulates water usage depending on the type and degree of soiling
Der AquaSensor regelt den Wasserverbrauch abhängig von Art und Stärke der Geschirverschmutzung



Number of programs/temperatures
Anzahl der Programme/Temperaturen



Cable length, m
Kabellänge, m



Класс энергоэффективности
Energy class
Energieeffizienzklasse



Total electricity loading, W
Max. Gesamtanschlusswert, Watt

Integrated dishwashers Einbaugeschirrspüler

Electrolux



AirDry

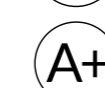

ESL95324LO

Number of settings: 13
Time delay function: 1-24 hours
Beam on Floor: red and green
Rinse aid and salt indicators
Time remaining indicator
Dishwasher programs: AutoFlex 45°-70°, Eco 50°, Intensive 70°C, QuickPlus 60°, Rinse & Hold
Appliance dimensions (HxWxD), mm: 818x596x550
Installation dimensions (HxWxD), mm: 820-880x600x550
Inlet/outlet hose length, m: 1.5

Fassungsvermögen: 13 Maßgedecke
Startzeitvorwahl: 1-24 Stunden
Beam on Floor: rot und grün
Nachfüllanzeige für Salz und Klarspüler
Restlaufanzeige
Programme: AutoFlex 45°-70°, Eco 50°, Intensiv 70°C, QuickPlus 60°, Vorspülen
Gerätemaße (HxBxT), mm: 818x596x550
Einbaumaße (HxBxT), mm: 820-880x600x550
Länge der Anschlüsse (Zulauf/Ablauf), m: 1,5

Electrolux

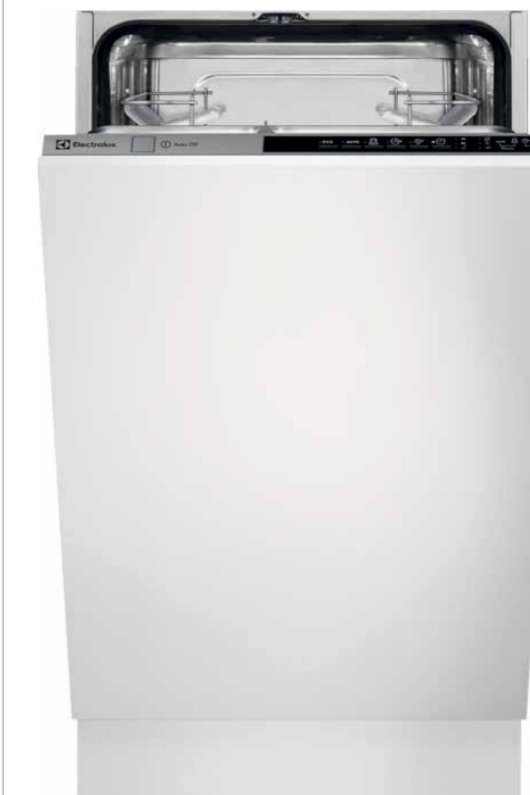

AirDry

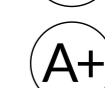

ESL94320LA

Number of settings: 9
Time delay function: 3 or 6 hours
Rinse aid and salt indicators
Dishwasher programs: AutoFlex 45°-70°, Eco 50°, Intensive 70°C, QuickPlus 60°, Rinse & Hold
Appliance dimensions (HxWxD), mm: 818x446x550
Installation dimensions (HxWxD), mm: 820-880x450x550
Inlet/outlet hose length, m: 1.5

Fassungsvermögen: 9 Maßgedecke
Startzeitvorwahl: 3 oder 6 Stunden
Nachfüllanzeige für Salz und Klarspüler
Programme: AutoFlex 45°-70°, Eco 50°, Intensiv 70°C, QuickPlus 60°, Vorspülen
Gerätemaße (HxBxT), mm: 818x446x550
Einbaumaße (HxBxT), mm: 820-880x450x550
Länge der Anschlüsse (Zulauf/Ablauf), m: 1,5

AEG**FSR52610Z**

Number of settings: 13
 Time delay function: 1-24 hours
 Beam on Floor: red and green
 Rinse aid and salt indicators
 Time remaining indicator
 Dishwasher programs: 30 Minutes 60°, AutoSense 45°-70°, Eco 50°, Glass 45°, Intensive 70°C
 Appliance dimensions (HxWxD), mm: 818x596x550
 Installation dimensions (HxWxD), mm: 820-880x600x550
 Inlet/outlet hose length, m: 1,5

Fassungsvermögen: 13 Maßgedecke
 Startzeitvorwahl: 1-24 Stunden
 Beam on Floor: rot und grün
 Nachfüllanzeige für Salz und Klarspüler
 Restlaufanzeige
 Programme: 30 Minuten 60°, AutoSense 45°-70°, Eco 50°, Glas 45°, Intensiv 70°C
 Gerätegröße (HxBxT), mm: 818x596x550
 Einbaumaße (HxBxT), mm: 820-880x600x550
 Länge der Anschlüsse (Zulauf/Abfluss), m: 1,5

AEG**FSR62400P**

Number of settings: 9
 Time delay function: 1-24 hours
 Beam on Floor: red and green
 Rinse aid and salt indicators
 Time remaining indicator
 Dishwasher programs: 30 Minutes 60°, AutoSense 45°-70°, Eco 50°, Extra Silent (43dB), Glass 45°, Intensive 70°C
 Appliance dimensions (HxWxD), mm: 818x446x550
 Installation dimensions (HxWxD), mm: 820-900x450x550
 Inlet/outlet hose length, m: 1,5

Fassungsvermögen: 9 Maßgedecke
 Startzeitvorwahl: 1-24 Stunden
 Beam on Floor: rot und grün
 Nachfüllanzeige für Salz und Klarspüler
 Restlaufanzeige
 Programme: 30 Minuten 60°, AutoSense 45°-70°, Eco 50°, Extra Silent (43dB), Glas 45°, Intensiv 70°C
 Gerätegröße (HxBxT), mm: 818x446x550
 Einbaumaße (HxBxT), mm: 820-900x450x550
 Länge der Anschlüsse (Zulauf/Abfluss), m: 1,5

BOSCH**SMV46IX01R**

Number of settings: 13
 Time delay function: 1-24 hours
 InfoLight: red beam on floor
 Rinse aid and salt indicators
 Dishwasher programs: Silent 50° (41dB), Auto 45°-65°, Eco 50°, Quick wash 65°, Intensive 70°C, pre-rinse
 Appliance dimensions (HxWxD), mm: 815x598x550
 Installation dimensions (HxWxD), mm: 815-875x600x550
 Inlet/outlet hose length, m: 1,65 / 1,90

Fassungsvermögen: 13 Maßgedecke
 Startzeitvorwahl: 1-24 Stunden
 InfoLight: ein roter Lichtpunkt auf dem Fußboden
 Nachfüllanzeige für Salz und Klarspüler
 Programme: Silent 50° (41dB), Auto 45°-65°, Eco 50°, Quick wash 65°, Intensiv 70°C, Vorspülen
 Gerätegröße (HxBxT), mm: 815x598x550
 Einbaumaße (HxBxT), mm: 815-875x600x550
 Länge der Anschlüsse (Zulauf/Abfluss), m: 1,65 / 1,90

BOSCH**SPV25FX30R**

Number of settings: 10
 Time delay function: 3, 6, 9 hours
 InfoLight: red beam on floor
 Rinse aid and salt indicators
 Dishwasher programs: Auto 45-65°, Eco 50°, Silent 50° (43dB), Quick 65° (60 Minutes), Quick 45° (29 Minutes)
 Appliance dimensions (HxWxD), mm: 815x448x550
 Installation dimensions (HxWxD), mm: 815-875x450x550
 Inlet/outlet hose length, m: 1,65 / 2,05

Fassungsvermögen: 10 Maßgedecke
 Startzeitvorwahl: 3, 6, 9 Stunden
 InfoLight: ein roter Lichtpunkt auf dem Fußboden
 Nachfüllanzeige für Salz und Klarspüler
 Programme: Auto 45-65°, Eco 50°, Silent 50° (43dB), Quick 65° (60 Minuten), Quick 45° (29 Minuten)
 Gerätegröße (HxBxT), mm: 815x448x550
 Einbaumaße (HxBxT), mm: 815-875x450x550
 Länge der Anschlüsse (Zulauf/Abfluss), m: 1,65 / 2,05

REFRIGERATORS, FRIDGE-FREEZERS, FREEZERS KÜHL-, GEFRIERSCHRÄNKE

Integrated fridge-freezers Integrierte Kühl-Gefrierkombinationen

Electrolux



ENN92811BW

Color: white
 Fridge capacity (net), l: 196
 Freezer capacity (net), l: 72
 FreeStore system: even distribution of cooled air
 Freezer defrosting: manual
 Freezing capacity, kg/24h: 4
 Rising time, h: 22
 Control type: mechanical
 Appliance dimensions (HxWxD), mm: 1772x540x549
 Installation dimensions (HxWxD), mm: 1780x560x560

Farbe: weiß
 Nutzinhalt (Kühlteil), l: 196
 Nutzinhalt (Gefrierteil), l: 72
 FreeStore-System: eine gleichmäßige Zirkulation der Kaltluft
 Abtauvorgang: manuell
 Gefrierleistung, kg/24Std.: 4
 Lagerzeit bei Störung, Std.: 22
 Steuerung: mechanisch
 Gerätemaße (HxBxT), mm: 1772x540x549
 Einbaumaße (HxBxT), mm: 1780x560x560

AEG



SCR41811LS

Color: white
 Fridge capacity (net), l: 196
 Freezer capacity (net), l: 72
 Defrosting system of freezer: Static LowFrost technology
 Freezing capacity, kg/24h: 4
 Rising time, h: 22
 Appliance dimensions (HxWxD), mm: 1772x540x549 Installation dimensions (HxWxD), mm: 1780x560x560

Farbe: weiß
 Nutzinhalt (Kühlteil), l: 196
 Nutzinhalt (Gefrierteil), l: 72
 Abtautechnik im Gefrierteil: Static LowFrost
 Gefrierleistung, kg/24Std.: 4
 Lagerzeit bei Störung, Std.: 22
 Gerätemaße (HxBxT), mm: 1772x540x549
 Einbaumaße (HxBxT), mm: 1780x560x560



Noise level, dB
Geräuschpegel, dB



TouchSensor control
TouchSensor-Bedienung



Cable length, m
Kabellänge, m



Energy class
Energieeffizienzklasse



Total electricity loading, W
Anschlusswert, Watt

Integrated fridge-freezer
Integrierte Kühl-Gefrierkombination

BOSCH



KIV38X22RU

Color: white
Fridge capacity (net), l: 217
Freezer capacity (net), l: 60
Freezer defrosting: manual
Freezing capacity, kg/24h: 6
Rising time, h: 13
Control type: electronic
Appliance dimensions (HxWxD), mm: 1770x540x550
Installation dimensions (HxWxD), mm: 1775x562x550

Farbe: weiß
Nutzinhalt (Kühlteil), l: 217
Nutzinhalt (Gefrierteil), l: 60
Abtauvorgang: manuell
Gefrierleistung, kg/24Std.: 6
Lagerzeit bei Störung, Std.: 13
Steuerung: elektronisch
Gerätemaße (HxBxT), mm: 1770x540x550
Einbaumaße (HxBxT), mm: 1775x562x550

Integrated refrigerator Integrierter Kühlschrank

AEG



SKE81826ZC

Color: white
Fridge capacity (net), l: 200
Zero Zone capacity (net), l: 75
Coolmatic function for quick cooling of fresh goods
Door with soft closing feature
Appliance dimensions (HxWxD), mm: 1769x556x549
Installation dimensions (HxWxD), mm: 1780x560x560

Farbe: weiß
Nutzinhalt (Kühlteil), l: 200
Nutzinhalt (0°C-Kaltraum), l: 75
Coolmatic-Funktion zum schnellen Kühlen frischer Lebensmittel
Türschließdämpfung SoftClosing
Gerätemaße (HxBxT), mm: 1769x556x549
Einbaumaße (HxBxT), mm: 1780x560x560

Integrated freezer Integrierter
Gefrierschrank

AEG













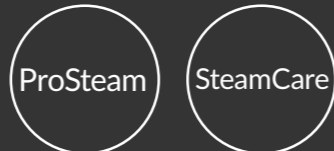

ABB68211AF

Color: white
Freezer capacity (net), l: 95
Frostmatic fast freeze function
Freezer defrosting: manual
Freezing capacity, kg/24h: 18
Rising time, h: 21
Control type: electronic
Appliance dimensions (HxWxD), mm: 815x596x550
Installation dimensions (HxWxD), mm: 820x600x550

Farbe: weiß
Nutzinhalt, l: 95
Frostmatic-Funktion für schnelles und schonendes Gefrieren
Abtauvorgang: manuell
Gefrierleistung, kg/24Std.: 18
Lagerzeit bei Störung, Std.: 21
Steuerung: elektronisch
Gerätemaße (HxBxT), mm: 815x596x550
Einbaumaße (HxBxT), mm: 820x600x550

WASHING MACHINES, WASHER DRYERS, DRYERS WASCHMASCHINEN, WASHTROCKER, WÄSCHETROCKNER

 Washing capacity, kg Fassungsvermögen (Waschen), kg	 Загрузка для сушки, кг Drying capacity, kg Fassungsvermögen (Trocknen), kg	 ProSteam / SteamCare technology: steam treatment ProSteam-/SteamCare-Technologie: Dampfbehandlung	 Fuzzy Logic Control Fuzzy Logic Funktion
 SoftPlus system: even softer distribution SoftPlus-Option: gleichmäßige Verteilung des Weichspülers	 DualSense technology for sensitive care DualSense-Technologie für schonende Pflege	 ProSense / SensiCare technology automatically weighs each load to provide a tailored cycle ProSense- / SensiCare-Technologie ermittelt jede Beladungsmenge, um den Vorgang dahingehend anzupassen	 Foam control Schaumerkennung
 Washing/spinning/drying noise level, dB Geräuschwert Waschen/Schleudern/Trocknen, dB	 Cable length, m Kabellänge, m	 Energy class Energieeffizienzklasse	 Total electricity loading, W Anschlusswert, Watt

Freestanding front loaded washing machine Freistehende Frontlader-Waschmaschine

AEG



L7FBE48SR

Color: white
Motor system: Inverter, permanent magnet
Spin speed, rpm: max. 1400
Delay start option
AquaControl sensor
LCD display
Appliance dimensions (HxWxD), mm: 850x600x571
Inlet/outlet hose length, m: 1.5 / 1.4
Wash/spin performance: B/B

Farbe: weiß
Motorsystem: Inverter, Permanentmagnet
Schleudertouren, U/min: 1400
Startzeitvorwahl
Sicherheitseinrichtung: AquaControl-Sensor
Displaytyp: LCD-Display
Gerätemaße (HxBxT), mm: 850x600x571
Länge der Anschlüsse (Zulauf/Ablauf), m: 1.5 / 1.4
Wasch-/Schleuderwirkungsklasse: B/B

Integrated washing machine Einbau-Waschmaschine

Electrolux



EW7F3R48SI

Color: white
Motor system: Inverter, permanent magnet
Spin speed, rpm: max. 1400
Delay start option
AquaControl sensor
LCD display
Appliance dimensions (HxWxD), mm: 819x596x540
Inlet/outlet hose length, m: 1.5 / 1.4
Wash/spin performance: A/B

Farbe: weiß
Motorsystem: Inverter, Permanentmagnet
Schleudertouren, U/min: 1400
Startzeitvorwahl
Sicherheitseinrichtung: AquaControl-Sensor
Displaytyp: LCD-Display
Gerätemaße (HxBxT), mm: 819x596x540
Länge der Anschlüsse (Zulauf/Ablauf), m: 1.5 / 1.4
Wasch-/Schleuderwirkungsklasse: A/B

Freestanding washer dryer Freistehender Waschtrockner

AEG



L8WBC61S

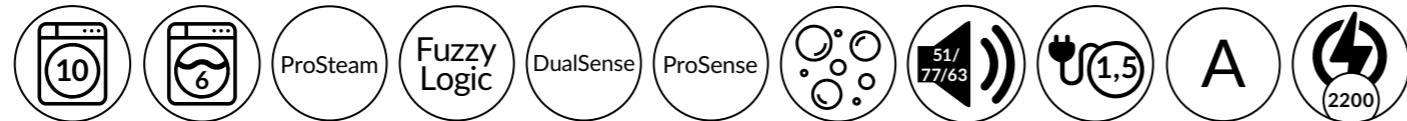

Color: white
 Motor system: Inverter, permanent magnet
 Drying technology: condenser dryer
 Spin speed, rpm: max. 1600
 Delay start option
 AquaControl sensor
 Out-of-balance detection and correction capability
 ÖKOMix technology pre-mixes detergents and softener separately in water before they enter the drum
 LCD display
 Appliance dimensions (HxWxD), mm: 850x600x605
 Inlet/outlet hose length, m: 1,5 / 1,4
 Wash/spin performance: A/A

Farbe: weiß
 Motorsystem: Inverter, Permanentmagnet
 Trocknungstechnologie: Kondensationstrocknung
 Schleudertouren, U/min: 1600
 Startzeitvorwahl
 Sicherheitseinrichtung: AquaControl-Sensor
 Unwuchtkontroll- und Korrektursystem
 ÖKOMix-Technologie: Waschmittel und Weichspüler werden jeweils mit Wasser vorgemischt, bevor sie in die Trommel kommen
 Displaytyp: LCD-Display
 Gerätemaße (HxBxT), mm: 850x600x605
 Länge der Anschlüsse (Zulauf/Abfluss), m: 1,5 / 1,4
 Wasch-/Schleuderwirkungsklasse: A/A

Integrated washer dryer Integrierter Waschtrockner

AEG



L8WBE68SRI

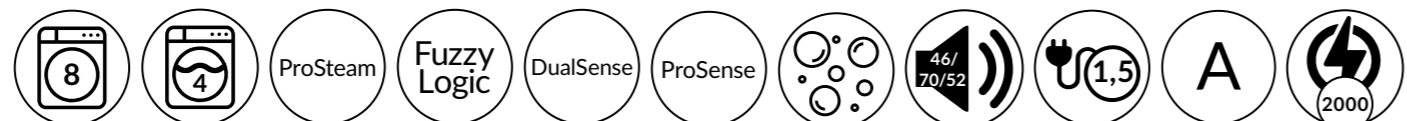

Color: white
 Motor system: Inverter, permanent magnet
 Drying technology: condenser dryer
 Spin speed, rpm: max. 1600
 Delay start option
 AquaControl sensor
 Out-of-balance detection and correction capability
 LCD display
 Appliance dimensions (HxWxD), mm: 819x596x540
 Inlet/outlet hose length, m: 1,5 / 1,4
 Wash/spin/dry performance: A/A/A

Farbe: weiß
 Motorsystem: Inverter, Permanentmagnet
 Trocknungstechnologie: Kondensationstrocknung
 Schleudertouren, U/min: 1600
 Startzeitvorwahl
 Sicherheitseinrichtung: AquaControl-Sensor
 Unwuchtkontroll- und Korrektursystem
 Displaytyp: LCD-Display
 Gerätemaße (HxBxT), mm: 819x596x540
 Länge der Anschlüsse (Zulauf/Abfluss), m: 1,5 / 1,4
 Wasch-/Schleuder/Trocknungswirkungsklasse: A/A/A

Freestanding dryer Freistehender Wäschetrockner

AEG



T8DEE48S

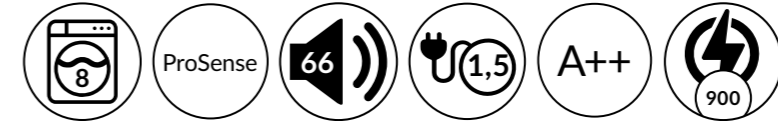

Color: white
 Motor system: Inverter, permanent magnet
 Drying technology: Heat pump condenser dryer
 Programs: Cupboard dry +, Extra dry, Iron dry
 AbsoluteCare system: precisely controls the movement and temperature of the drying drum to provide a tailored drying cycle
 Delay start option
 LCD display
 Included accessories: direct drain hose
 Appliance dimensions (HxWxD), mm: 850x600x600
 Condensation efficiency: B

Farbe: weiß
 Motorsystem: Inverter, Permanentmagnet
 Trocknungstechnologie: Kondensrockner mit Wärmepumpentechnologie
 Programme: Schranktrocken +, Extratrocken, Bügeltrocken
 AbsoluteCare-System: steuert die Bewegungen der Trommel und die Trocknungstemperatur präzise, um den Trocknungsvorgang anzupassen
 Startzeitvorwahl
 Displaytyp: LCD-Display
 Mitgeliefertes Zubehör: Ablaufschlauch für Kondenswasser
 Gerätemaße (HxBxT), mm: 850x600x600
 Kondensations-Effizienzklasse: B

Stacking kit with pull-out shelf for washing machines and tumble dryers Verbindungssatz für Waschmaschinen und Trockner mit Auszugsplatte



STA9GW

Suitable for 600mm wide and 530-630mm deep machines
 Integrated shelf can be pulled out by up to 340mm

Für 600mm breite und 530-630mm tiefe Maschinen
 Die Auszugsplatte kann bis zu 340mm herausgezogen werden

EXTRACTOR HOODS

DUNSTABZUGSHAUBEN

 elica



CIAKLUXGR/A/L/56

Built-in telescopic extractor hood
 Width, mm: 600
 Color: silver
 Material: stainless steel, glass
 Control: Slider
 Power levels: 3
 Duct size, mm: 120
 Lighting: LED 2x2,5 W

Einbau-Dunstabzugshaube mit Teleskopauszug
 Breite, mm: 600
 Farbe: Silber
 Material: Edelstahl, Glas
 Steuerung: Slider
 Leistungsstufen: 3
 Abluftstutzen, mm: 120
 Beleuchtung: LED 2x2,5 W



 elica



ELITE14LUXGRVTWH/A/60

Built-in telescopic extractor hood
 Width, mm: 600
 Color: silver
 Material: stainless steel, glass
 Control: mechanical push button
 Power levels: 3
 Duct size, mm: 120
 Lighting: LED 2x3 W

Einbau-Dunstabzugshaube mit Teleskopauszug
 Breite, mm: 600
 Farbe: Silber
 Material: Edelstahl, Glas
 Steuerung: mechanisches Tastenfeld
 Leistungsstufen: 3
 Abluftstutzen, mm: 120
 Beleuchtung: LED 2x3 W



Noise level, dB
 Geräuschpegel, dB



Extraction capacity, m³/h Leistung,
 m³/St.



Energy class
 Energieeffizienzklasse



Total electricity loading, W
 Anschlusswert, Watt



ERAGR/A/52

Built-in extractor hood
 Width, mm: 600
 Color: silver
 Material: stainless steel
 Control: Slider
 Power levels: 3
 Duct size, mm: 120
 Lighting: LED 2x3 W

Einbau-Dunstabzugshaube
 Breite, mm: 600
 Farbe: Silber
 Material: Edelstahl
 Steuerung: Slider
 Leistungsstufen: 3
 Abluftstutzen, mm: 120
 Beleuchtung: LED 2x3 W



ERAGR/A/72

Built-in extractor hood
 Width, mm: 800
 Color: silver
 Material: stainless steel
 Control: Slider
 Power levels: 3
 Duct size, mm: 120
 Lighting: LED 2x3 W

Einbau-Dunstabzugshaube
 Breite, mm: 800
 Farbe: Silber
 Material: Edelstahl
 Steuerung: Slider
 Leistungsstufen: 3
 Abluftstutzen, mm: 120
 Beleuchtung: LED 2x3 W



HIDDENIX/A/60

Built-in extractor hood
 Width, mm: 600
 Color: silver
 Material: stainless steel, glass
 Control: Touch Control
 Power levels: 4
 Duct size, mm: 150
 Lighting: LED strip 1x7 W

Einbau-Dunstabzugshaube
 Breite, mm: 600
 Farbe: Silber
 Material: Edelstahl, Glas
 Steuerung: Touch Control Leistungsstufen:
 4
 Abluftstutzen, mm: 150
 Beleuchtung: LED-Streife 1x7 W



HIDDENIX/A/90

Built-in extractor hood
 Width, mm: 900
 Color: silver
 Material: stainless steel, glass
 Control: Touch Control
 Power levels: 4
 Duct size, mm: 150
 Lighting: LED strip 1x7 W

Einbau-Dunstabzugshaube
 Breite, mm: 900
 Farbe: Silber
 Material: Edelstahl, Glas
 Steuerung: Touch Control Leistungsstufen:
 4
 Abluftstutzen, mm: 150
 Beleuchtung: LED-Streife 1x7 W





ELIBLOCHTGR/A/60

Built-in extractor hood
 Width, mm: 600
 Color: silver
 Material: stainless steel
 Control: Slider
 Power levels: 4
 Duct size, mm: 150
 Lighting: LED 2x5 W

Einbau-Dunstabzugshaube
 Breite, mm: 600
 Farbe: Silber
 Material: Edelstahl
 Steuerung: Slider
 Leistungsstufen: 4
 Abluftstutzen, mm: 150
 Beleuchtung: LED 2x5 W



SLIMMYGLSTDGR/A/60

Built-in telescopic extractor hood
 Width, mm: 600
 Color: silver
 Material: stainless steel, glass
 Control: mechanical push button
 Power levels: 3
 Duct size, mm: 120
 Lighting: halogen 2x28 W

Einbau-Dunstabzugshaube mit Teleskopauszug
 Breite, mm: 600
 Farbe: Silber
 Material: Edelstahl, Glas
 Steuerung: mechanisches Tastenfeld
 Leistungsstufen: 3
 Abluftstutzen, mm: 120
 Beleuchtung: Halogen 2x28 W



DWK065G20R

Chimney extractor hood
 Width, mm: 600
 Color: white
 Material: stainless steel, glass
 Control: Touch Control
 Power levels: 3
 Duct size, mm: 120 / 150
 Lighting: LED

Dunstabzugshaube im Schrägessen-Design
 Breite, mm: 600
 Farbe: weiß
 Material: Edelstahl, Glas
 Steuerung: Touch Control
 Leistungsstufen: 3
 Abluftstutzen, mm: 120 / 150
 Beleuchtung: LED



DWK065G60R

Chimney extractor hood
 Width, mm: 600
 Color: black
 Material: stainless steel, glass
 Control: Touch Control
 Power levels: 3
 Duct size, mm: 120 / 150
 Lighting: LED

Dunstabzugshaube im Schrägessen-Design
 Breite, mm: 600
 Farbe: schwarz
 Material: Edelstahl, Glas
 Steuerung: Touch Control
 Leistungsstufen: 3
 Abluftstutzen, mm: 120 / 150
 Beleuchtung: LED



BOSCH



DHL575C

Built-in extractor hood
 Width, mm: 600
 Color: silver
 Material: stainless steel
 Control: mechanical push button
 Power levels: 3 + intensive
 Duct size, mm: 120 / 150
 Lighting: LED 2x20 W

Einbau-Dunstabzugshaube
 Breite, mm: 600
 Farbe: Silber
 Material: Edelstahl
 Steuerung: mechanisches Tastenfeld Leistungsstufen:
 3 + intensiv
 Abluftstutzen, mm: 120 / 150
 Beleuchtung: LED 2x20 W

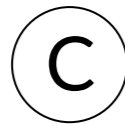

BOSCH



DHL555BL

Built-in extractor hood
 Width, mm: 600
 Color: silver
 Material: stainless steel
 Control: Slider
 Power levels: 3 + intensive
 Duct size, mm: 120 / 150
 Lighting: LED 2x3 W

Einbau-Dunstabzugshaube
 Breite, mm: 600
 Farbe: Silber
 Material: Edelstahl
 Steuerung: Slider
 Leistungsstufen: 3 + intensiv
 Abluftstutzen, mm: 120 / 150
 Beleuchtung: LED 2x3 W



WWW.ZOVKUCHNIE.PL